

40 *Years*
1985 2025

LARIDENT

MADE IN ITALY
SINCE 1985





Larident was founded in 1985, but the story starts much earlier than that! The founder of the company, Mr. Giuliano Cataldi, started to work in the sector of sanitary products distribution in Genoa right after the Second World War. In 1961 he starts the distribution of chemical products and alloys for the dental sector. In 1985 the company is renewed with the entry of his son Alessandro Cataldi, that comes from another company extensively involved in the dental sector, and subsequently the company Larident is founded on 21st January 1985. The sanitary sector is abandoned and the company concentrates on the **dental sector producing plastic articles for dentists**. The quality of the products and their competitiveness on the market make the export market a fundamental part of the company from the beginning, and reached a 50% share of the turn-over in 2014. At present, Larident has a commercial department that **distributes its own products all over Italy and in 70 other countries**. On the Italian market it represents and distributes products from well-known manufacturers like Hager & Werken (dentistry and lab products), Polirapid (brushes for laboratories), Nordiska Dental (filling materials) and more. Another strength of Larident is its flexibility in the manufacturing of **personalized products for private label** purposes. In its efficient industrial division, equipped with nine injection moulding machines used for the production of

its 500 different articles, it is possible to develop new products with the clients starting from only an idea. Amongst the products with the biggest success are, e.g. the **prosthesis container boxes** that in 2024 about **10.000.000 pieces** were produced and sold, a wide range of protection visors, bur holders with the widest assortment available on the market. Over time many disposable articles, e.g. disposable trays manufactured in 3 different materials and 27 models. The specialisation in the production of articles in private label is a specialty recognized on an international level. Larident has been developing the production of a **BIO** line for over 10 years, made up of natural or recycled origin materials, anticipating a trend that is increasingly present; in this catalogue we'd like to present further innovations and developments. Larident cooperates with the main national manufacturers in the diffusion of products made in Italy throughout the world. Larident is a **certified company** and here are the specific certificates:

- ISO 9001/2000 certification since 1997 with modification in 2018 to **ISO 9001/2015 certification**
- 14001/2004 certification since 2010 renewed in 2016 with **ISO 14001/2015** to demonstrate its specific awareness concerning quality and the environment
- ISO 13485/2012 certification since 2012 renewed in 2019 with **ISO 13485/2016** regarding medical devices.

To get to know more [interview with CEO Alessandro Cataldi](#).



Accessories for impression trays.....	60	Lab products.....	103 - 104
Aligner cases.....	48	Metal bur holders.....	84
Aluminium trays.....	64 - 65	Mini sandblaster.....	96 - 97
Articulators.....	112 - 113	Mouthwash.....	54
Bases.....	20	Organizers.....	36 - 37 - 68
Bib holders.....	19	Orthodontics.....	38 - 39 - 40
Bibs.....	17		42 - 43 - 44
Bio.....	6 - 7 - 8 - 9		45 - 46 - 47
Bowls.....	102	Paper.....	16
Boxes.....	119	PET trays.....	13
Bur holder.....	86	Laboratory bur holders.....	87
Cannula Zero.....	25	Plastic trays.....	67
Casting rings.....	100 - 101	Polystyrene trays.....	12
Ceramic brushes.....	110 - 111	Prosthesis boxes.....	41
Cold-curing resin.....	114	Protective glasses.....	88
Composite syringes containers.....	69	Protective visors.....	89 - 90
Conservative.....	28 - 29 - 30		91 - 92
	80 - 81	Resin and pumice.....	117
Cotton holders.....	32	Safety boxes.....	70 - 71
Cotton roll containers.....	33	Saliva ejectors.....	23
Cups.....	21	Sprays.....	63
Devices.....	118	Steam generators.....	98 - 99
Disinfection.....	58 - 59 - 61	Sterilizable bur holders.....	85
Dispensers.....	35	Sterilizable Melamine.....	10 - 11
Elastomer syringes.....	26	Sterilization reels and pouches.....	22
Endodontics.....	31 - 72 - 73	Syringes.....	27
	74 - 75 - 76 77	Teaching models.....	120 - 121
Enlarging.....	93	Thermoforming.....	49
Extraoral Suction System.....	24	Thermoplastic discs.....	50 - 51
Flasks for thermoplastics and composites.....	115	Towels.....	18
Gadgets.....	122 - 123	Transporting boxes.....	105
Glass products.....	94 - 95	Trays.....	14 - 15
Glove containers.....	34	Turbine accessories.....	62
Implantology.....	52 - 53 - 55	Universal bur holders.....	82 - 83
Impression trays.....	56 - 57	Work trays.....	106 - 107
Inox trays.....	66		108 - 109
Instruments.....	116	Xray envelopes and archives.....	78 - 79







BIO CUPS

BIO-31

Disposable cups in Compostable PLA, capacity 180 ml. Cartons with 30 stacks of 50 cups each, packed in an eco bag, total 1500 pcs.

 4,90 each  36 cartons

COMPOSTABLE



BIO-31

PLA (Acido Poli-Lattico)

PLA is a compostable bioplastic and biodegradable. Find out more scanning the QR code.



BIO-32

Disposable paper cups in recyclable paper, capacity 200 ml, made with internal coating in PE plastic (polyethylene). Cartons with 20 stacks of 50 cups each, packed in PP plastic (polypropylene) bag, total 1000 pcs.

 4,70 each  40 cartons



RECYCLABLE



BIO-32

BIO-34

Disposable carton PEFC cups + PLA internal coating, COMPOSTABLE, capacity 180 ml. Cartons with 20 stacks of 50 cups each, packed in a plastic LDPE (polyethylene) bag, total 1000 pcs.

 5,20 each  40 cartons

COMPOSTABLE



BIO-34

MATER-BI



MATER-BI is a "family" of completely biodegradable and compostable bioplastics. Find out more scanning the QR code.



BIO-37

BIO coloured cups in Mater-Bi, capacity 200 ml. Pack of 1200 pcs, divided into 30 stacks of 40 pcs each.

AVAILABLE COLORS:
 Bl.  Gi.  Ro.  Ro.

 5,30 each  36 cartons

BIO-37

COMPOSTABLE





BIO TRAYS

BIO-20

Disposable tray in PLA, compostable vegetable origin polymer (derived from corn starch). High resistance and transparent colouring. Thickness 0.25 mm. Pack of 100 pcs.

 cm 28x18



BIO-20



COMPOSTABLE



BIO-24

Paper Tray + PE havana color. Carton 600 pcs, in 6 bags with 100 pcs each.

 cm 24,8x17,4 h2,2

BIO-24



BIO-26

BIO-26

Paper Tray + PE havana color. Carton 600 pcs, in 6 bags with 100 pcs each.

 cm 20,5x14,1 h2,4

RECYCLABLE



RECYCLABLE

BIO-50

Paper tray FSC certified, 16 layers with resistance procedure against water droplets. Package 100 pcs.

 cm 28x18

BIO-50

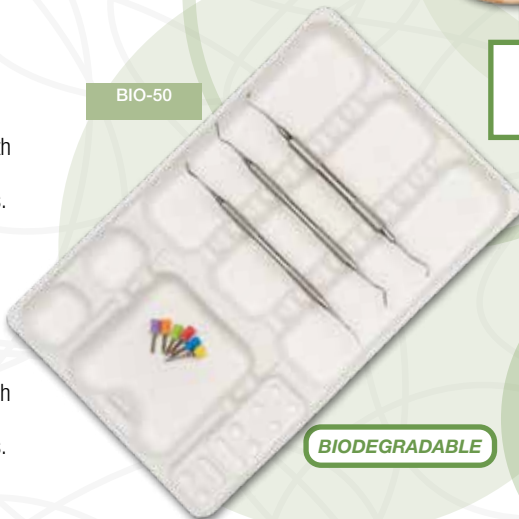

THE FIRST PAPER TRAY

BIO-51

BIO-51

Paper tray FSC certified, 16 layers with resistance procedure against water droplets. Package 100 pcs.

 cm 18x14

BIODEGRADABLE





BIO-11

Completely BIO in paper, plant-based polythene pad. The paper sheet colour is white. Consisting of 100 sheets of paper 0,13 mm thick. Non-slip base thanks to a special paint, with UV. Packaging 6 pads.

 cm 7x8



BIO-11

BIODEGRADABLE

BIODEGRADABLE



BIO-42

BIO-42

Paper napkin in recycled paper, natural sand colour. 2-ply, 1 paper/1 plastic. Pack of 500 pcs.

 Open cm 45x32.2
Folded cm 16,1x11,3

BIO-44

Paper napkin in fully recycled paper, grey natural colour, without colourings, 1-ply, C-folded, gr/m2 40, 3000 pcs/pack.

 Open cm 23x33
Folded cm 23x10



BIO-44

BIODEGRADABLE

BIO-48

Bio wood plup disposable kidney shaped dishes 50 pcs.

 cm 15x25,5x5



BIO-48

BIODEGRADABLE

Compostable or biodegradable?
 The difference lies with the question of time. A biodegradable element is not automatically compostable. Find out more scanning the QR code.





BIO-22

Bio dappen in bio-based material. Polypropylene from bio masses origin. White colour. Box of 200 pcs.



BIO-22

RECYCLABLE

BIO-40

Ortho box in bio-based material. Polypropylene from bio masses origin. Box of 10 pcs.

 cm 8,3x8,4 h4,4



BIO-40



RECYCLABLE

BIO-46

Bite holder in bio-based material. Polypropylene from bio masses origin. Box of 10 pcs.

 cm 7,8x7,7 h3



RECYCLABLE

BIO-46

BIO-90  

BIO sponges for cleaning endodontic instruments. Thickness 0,5 mm. Pack of 50 pcs.

 cm ø5 h0,5



BIO-90

RECYCLABLE



BIO-92

BIO-92  

BIO sponges for cleaning endodontic instruments. Thickness 1 mm. Pack of 25 pcs.

 cm ø5 h1

Find out more about Bio-Sponge, scan the QR code.



Polyurethanes with a reduced environmental impact

Made through the use of high percentages of poly-based vegetable oils which replace part of the fossil origin raw materials, keeping the key features of the product unaltered.

35 P

35 kg/m³

 22%



121° STERILIZABLE

MEL-16

Tray made of melamine, with a smooth base and the possibility of inserting a metal rack with molded spaces for dental instruments.

AVAILABLE COLORS: Bi Az

cm 28,4x18,3x1,7

MEL-16

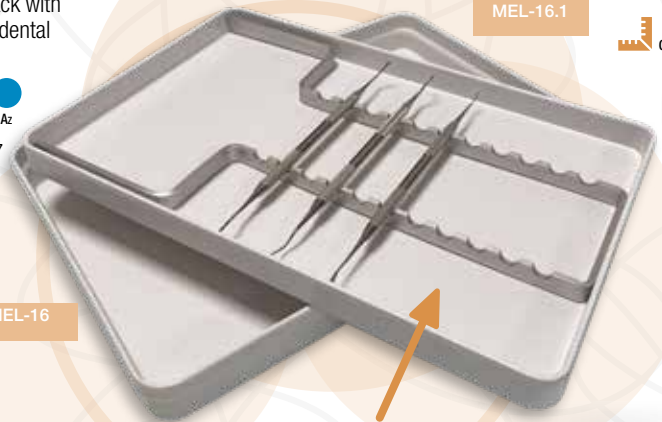

Rack 11 instruments code Q19.

MEL-16.1

Melamine cover for tray MEL-7 and MEL-16.

AVAILABLE COLORS: Bi Gi

cm 29x19 h3

MEL-16.1

MEL-CUP



MEL-52

Medium melamine tray container, perfect support for disposable tray code C52.

cm 20,7x14,4

MEL-52



MEL-CUP

Melamine beaker, 166 ml capacity.

AVAILABLE COLORS: Bi



MEL-TRAY

Tray made of melamine, with molded spaces for instruments, trays and mixing wells.

AVAILABLE COLORS:



 cm 28x18



MEL-TRAY

The MELAMINE Melochem we use complies with the compositional requirements needed by the Regulation 10/2011/EC concerning materials intended to come into contact with food. The material is durable, robust, resistant to solvents and acids and sterilizable at 121°C, therefore reusable. Melamine resembles plastic but it is not plastic: it can be defined as a sustainable material, as it is a

BPA-free thermosetting resin, i.e. free of bisphenol, and does not derive from hydrocarbons. It is not porous, it inhibits the growth and presence of bacteria, viruses and fungal substances and is non-deformable. Usually used in the food sector with products such as plates, cups and glasses. It is now also suitable for sanitary use with instrument trays and other devices in the dental sector.

MEL-7

Melamine tray with 12 molded spaces for dental instruments incorporated. A lid is possible (see code MEL.16.1).

AVAILABLE COLORS:

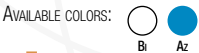

 cm 28,4x18,3



MEL-7



POLYSTYRENE TRAYS

C20

C20

Polystyrene plastic disposable tray, large, smooth surface, with raised edges, white, 400 pcs (in bags of 50 pcs).

 cm 28x18

 pcs: 72

RAW MATERIAL FOR FOOD USE



C21

Polystyrene plastic disposable tray, large, knurled surface, with raised edges, white, 400 pcs (in bags of 50 pcs).

 cm 28x18

 pcs: 72

C21

PS (polystyrene): plastic material with greater stiffness, chemically inert with respect to many corrosive materials.

C24

Assorted coloured disposable trays, polystyrene coloured plastic tray with knurled surface and raised edges, large, in assorted package.

AVAILABLE COLORS:  Ass

 cm 28x18

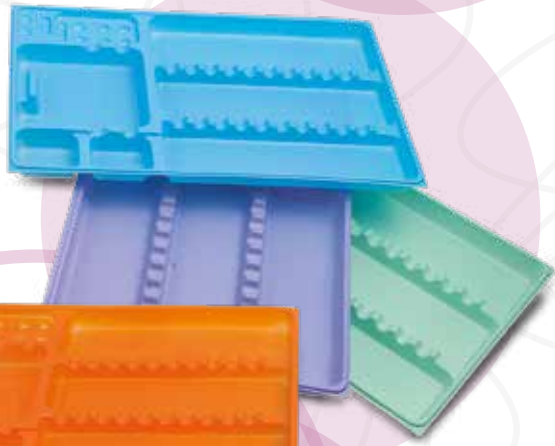

C25

Coloured disposable trays, polystyrene coloured plastic tray with knurled surface and raised edges, large, 400 pcs (in bags of 50 pcs).

AVAILABLE COLORS:  pcs: 72



 cm 28x18

C25

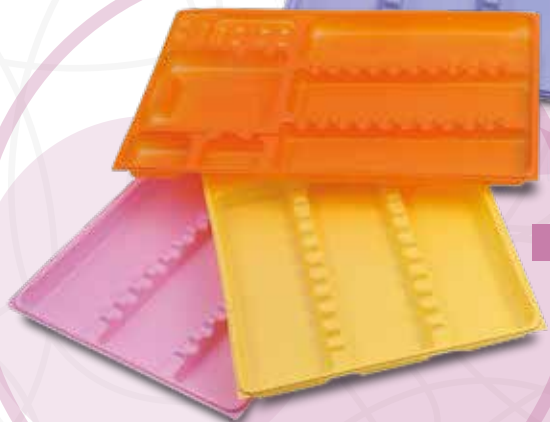



C22

PET disposable tray, large, smooth surface, with raised edges 400 pcs (in bags of 100 pcs).

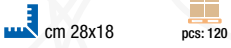

C22

RECYCLED AND RECYCLABLE MATERIAL FOR FOOD USE

C23

PET disposable tray, large, with knurled surface and raised edges, white, 400 pcs (in bags of 100 pcs).

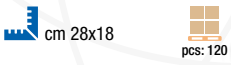

C23

PET: material that means it can be processed with reduced thickness while maintaining the same quality of robustness. Reduced thickness means less plastic, more cartons on the pallet and less pollution.

C29

PET disposable tray, large, with knurled surface and raised edges, white, 400 pcs (in bags of 200 pcs).



C29

C29-ASSORTED

PET disposable tray, large, with knurled surface and raised edges, 400 pcs (in single bag) in assorted package.

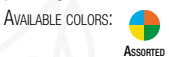

C29-COLOR

PET disposable tray, large, with knurled surface and raised edges, 400 pcs (in bags of 200 pcs).



C29-COLOR



TRAYS

C26

Small polystyrene plastic disposable tray, flat surface, with raised edges, white, 400 pcs. (in bags of 100 pcs).

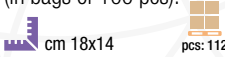

C26



C27

Small polystyrene plastic disposable tray, knurled surface, white, 400 pcs (in bags of 50 pcs).

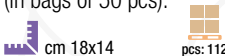

C27

C28

Polystyrene plastic disposable tray, small, knurled surface, white, 400 pcs (in bags of 100 pcs).



C28



C50

Disposable kidney shaped dish, packaging with 50 pcs.

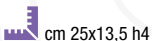

C50



**C39**

Disposable large tray without divided compartments, polystyrene, flat surface flare edge, white, package 400 pcs.

 cm 28x18



C39

C51

Disposable small tray without divided compartments, polystyrene, flare edge, knurled surface, white, 400 pcs.

 cm 20x10



C51

C52

Disposable medium tray without divided compartments, polystyrene, flare edge, knurled surface, white, 400 pcs.

 cm 20x15



C52



C40

Tray Paper, box with 10 packages with 250 pcs each.

AVAILABLE COLORS:



pcs: 56



cm 18x28

C40



C70

Head rest covers, made of cellulose + non sterile foil. Universal for dental chairs. Great protection for patient's head, easy to use. 1 package = 175 pieces.

AVAILABLE COLORS:



cm 29x30

C70

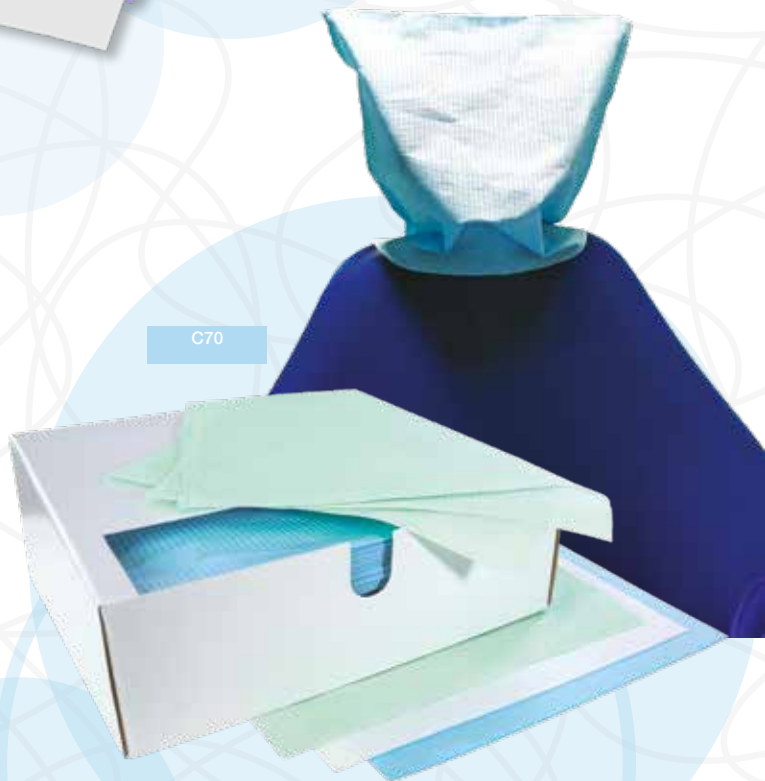



C42

C42

Paper towels, 3 plies, 2 paper plies / 1 PE ply, in package of 500 pcs, 8 colours available. Excellent absorption capacity and tear resistance.

AVAILABLE COLORS:



pcs: 80



Open cm 45x32,2
Folded cm 16,1x11,3

C62

Paper towels, 2 plies, 1 paper ply / 1 PE ply, in package of 500 pcs, 4 colours available. Excellent absorption capacity and tear resistance.

AVAILABLE COLORS:



pcs: 80

Open cm 45x32,2
Folded cm 16,1x11,3



C62

C60

Disposable bibs in roll in 2 layers of paper and coupled plastic, roll of 80 tears. Carton of 6 rolls.

AVAILABLE COLORS:



cm 60x50



pcs: 60

C60

A64

Hanging plastic dispenser for bibs in roll, white colour.

cm 28x13,6 h12,5



A64



TOWELS

C44



C44

1-ply C-folded paper towel, in recycled mixed paper/pure cellulose, packs of 3000 paper towels.

Open cm 23x33
Folded cm 23x10  pcs: 32

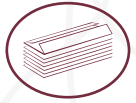

C48

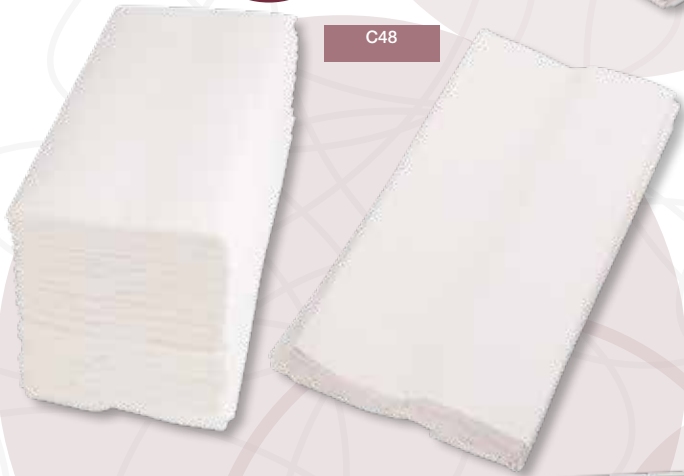

C48

2-ply C-folded Paper Towel, in pure cellulose paper, packs of 3060 paper towels.

Open cm 29,6x22,5
Folded cm 22,5x9,5  pcs: 32

C490

Paper towel sheets 2-ply V-folded interleaved, pure cellulose. Packs of 3000 sheets of paper (15x200).

Open cm 25x21,5
Folded cm 25x10,75  pcs: 52



C490



A68



A68

Dispenser for C-folded or V-folded paper towels, contains 250 pcs, mounted on the wall with four screws (included), with lock, white colour.

 cm 29x29 h11



A31

Thermoplastic rubber bib holder, sterilizable at 121°C. Packaging with 4 pcs, individually packed. Each holder is scented suitably to the colour.

AVAILABLE COLORS:



A31



Intense and resistant fragrance after being through various steps in the autoclave machine.

A32

Thermoplastic rubber bib holder, sterilizable at 121°C. Packaging of 10 pcs, in assorted colours.

AVAILABLE COLORS:



A33

Thermoplastic rubber bib holder, sterilizable at 121°C. Packaging in 4 pcs.

AVAILABLE COLORS:

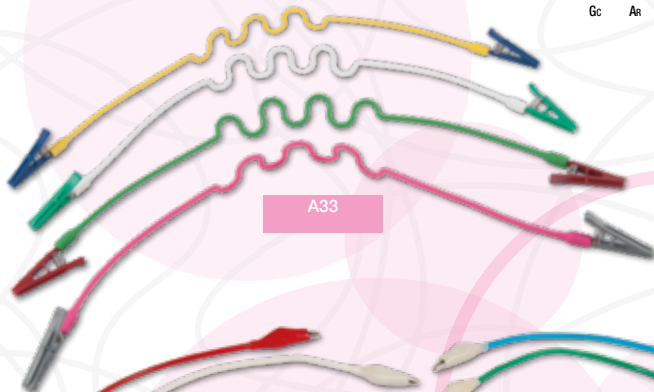

A33

A35

Rubber bib holder with metal clips. Bag of 10 pcs with assorted colours.



A35

A36

Metal holder pcs 10.



A36



BASES

C43

Waste container, 1000 pcs.

C43



C43.1

Alluminium base for waste container.

 cm ø6,5 h4,2

C43.1



C57

C57 CE

Tnt icepack, anti drip, package 25 pcs.



pcs: 81

R22 CE MD

Ice spray (-50°C), 200 ml container, non-toxic and cfc-free.

 master carton: 12 pz

R22



Useful for cooling off hydrocolloid type impression materials and glass plates. The plastic cannula can be used for more precise spraying, while direct spraying is recommended for impression pastes.

CUPS



G6

G6

Hangable cup dispenser, painted metal, for 50 cups.

AVAILABLE COLORS:



INOX STEEL



Inox

OTHER COLORS AVAILABLE ON REQUEST

 cm 8,5x8,5 h36



G93

G93

Hangable plastic cup dispenser with grey glass, holds 50 pcs.

 cm 10x9,5 h32



C38

C37

3000 plastic coloured cups for dental mouth rinses cc 200. Carton: 30 packages of 100 pcs each.

AVAILABLE COLORS:



pcs: 24



C37

C38

3000 white plastic cups for dental mouth rinses cc 166. Carton: 30 packages of 100 pcs each.

AVAILABLE COLORS:



Bi



pcs: 24

Disposable cups made of PS, compliant with European Law and Italian Regulations.



STERILIZATION REELS AND POUCHES

C71

Flat reels mm 50x200 mt.
Carton 8 pcs.



STERILIZATION REELS

Flat reels of special film with characteristics of resistance and good peel sealed to medical paper with high anti-bacterial protection. Suitable for steam sterilization, EO gas and formaldehyde.

C72

Flat reels mm 75x200 mt.
Carton 8 pcs.



C73

Flat reels mm 100x200 mt.
Carton 4 pcs.



C74

Flat reels mm 150x200 mt.
Carton 4 pcs.



C75

Flat reels mm 200x200 mt.
Carton 2 pcs.



C76

Flat reels mm 250x200 mt.
Carton 2 pcs.



External process indicators present on the product.
Indicator for ETO (GAS): Sterilized yellow/brown.
STEAM indicator: brown = sterilized. Sterility lasts for 5 years regarding bags and rolls for sterilization, as per tests carried out by a specific certified laboratory and available on request. Unless otherwise indicated by trade associations.



Paper grammage
60gr/m²



STERILIZATION POUCHES

Made up of a side of medical paper and one of film PET/PP peel. Suitable for sterilization by steam or EO gas. Double parameter of sterilization with internal and external indicators.

C780

Self sealing pouches 60x100 mm.
Box 21x200 pcs.



C783

Self sealing pouches 90x250 mm.
Box 12x200 pcs.



C784

Self sealing pouches 140x260 mm.
Box 8x200 pcs.





Disposable saliva ejectors made in non toxic PVC, metal wire, loose round tip, carton with 50 bags x 100 pcs = 5000 pcs. Available in opaque white color and 6 transparent colours.

C56



Long saliva ejectors.

AVAILABLE COLORS:



pcs: 36



Bi

OTHER COLORS AVAILABLE ON REQUEST

C56



A38

Transparent plexiglass saliva ejector dispenser, with cover, capacity 250 pcs.

 cm 16x14 h11,5

A38-DELUXE

Super transparent plexiglass saliva ejector dispenser, capacity 250 pcs.

 cm 17x15 h12

A38-DELUXE



A38



EXTRAORAL SUCTION SYSTEM

AEROSOLVEX

EXTRAORAL MODULAR SUCTION SYSTEM.

Aerosolvex is a suction system that works on the possibility of drastically eliminating aerosols and droplets that come out of the patient's mouth while the dentist is working.



C53

Complete pack AEROSOLVEX including central aspirator with side connections, aspirator tube with adapter, disposable silicone cheek retractors.

C53-SET

Complete pack AEROSOLVEX including central aspirator with side connections, aspirator tube with adapter, disposable silicone cheek retractors.



CENTRAL ASPIRATOR

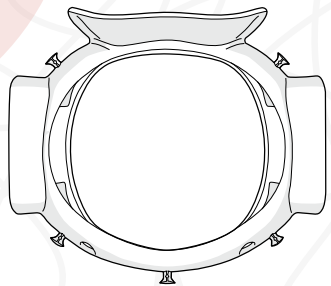

NASAL FLANGE

HOOKS FOR ELASTIC BANDS

TUBE CONNECTION

SUCTION NOZZLE

SALIVA EJECTOR HOLES

PIN FOR DAM

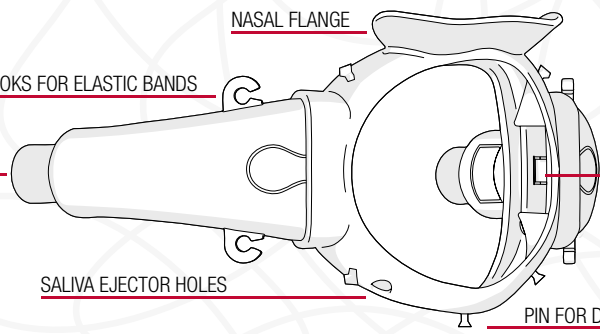



CANNULA “ZERO”

The “Zero” saliva ejector eliminates over 95% of the generated aerosol, it is made up of a double mirror, double suction and selector. The selector allows you to select the side and position it correctly in the mouth. Turning the selector to “O” (Open) opens the suction side from which you choose to work. The suction side “C” (Closed)

which comes into contact with the mucous membrane or tongue is automatically excluded. The material used is biocompatible, autoclavable, hypoallergenic, antitoxic and, above all, certified. A useful support for those that useGBT therapy, scaling, dentists, dental preparations or surgery, etc. Available in 2 colours, black or white.

C582 Mirror \varnothing 22 mm.

C584 Mirror \varnothing 24 mm.

AVAILABLE COLORS:



cm 13,5 \varnothing 1,5 handle
cm \varnothing 3 mirror holder



IMPORTANT

When changing the viewing side of the mirror it is necessary to select the suction side by acting on the selector. Then you have to turn the selector in the direction where you want to open the cannula suction.

Frame the QR code to find out more.

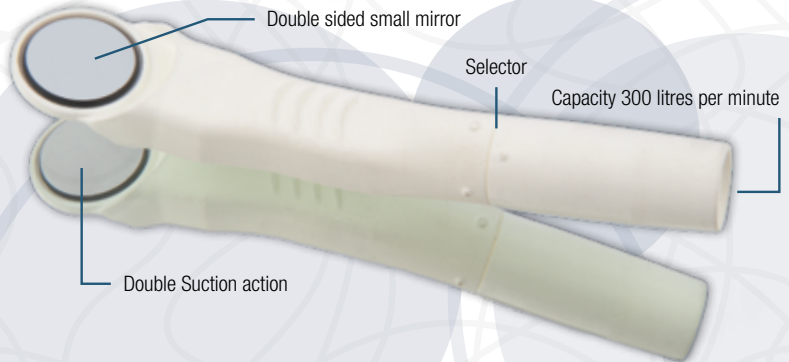

How to sterilize the Cannula Zero

After each use, the cannula, as well as all reusable medical devices, must absolutely be cleaned and sterilized. To avoid damage, especially to the mirror, it is advisable to follow some precautions for each type of procedure:

- immerse the cannula in a suitable disinfectant solution;
- strictly adhere to the correct concentration levels and disinfection times indicated by the manufacturer of the disinfectant solution;
- after disinfection, rinse away all residue of the disinfectant solution very well;
- in case of “resistant” residue, use a soft brush; never use abrasive instruments or solutions, especially on mirrors with surface deposits (rhodium, etc.);
- dry thoroughly after washing;
- in any case, absolutely avoid the use of ultrasound;
- sterilize in an autoclave machine at 121° (plastic or delicate cycle depending on the model);
- before inserting the mirror into the sterilizers, it must be absolutely dry and free of chemical solution residue or other residue; this is to avoid cracks, stains or corrosion;
- never exceed the suggested temperature.



ELASTOMER SYRINGES

A25

Elastomer dressing syringe, anodized aluminium, with 3 tips, o-ring and brush for cleaning.

 cm 10 ø1,5

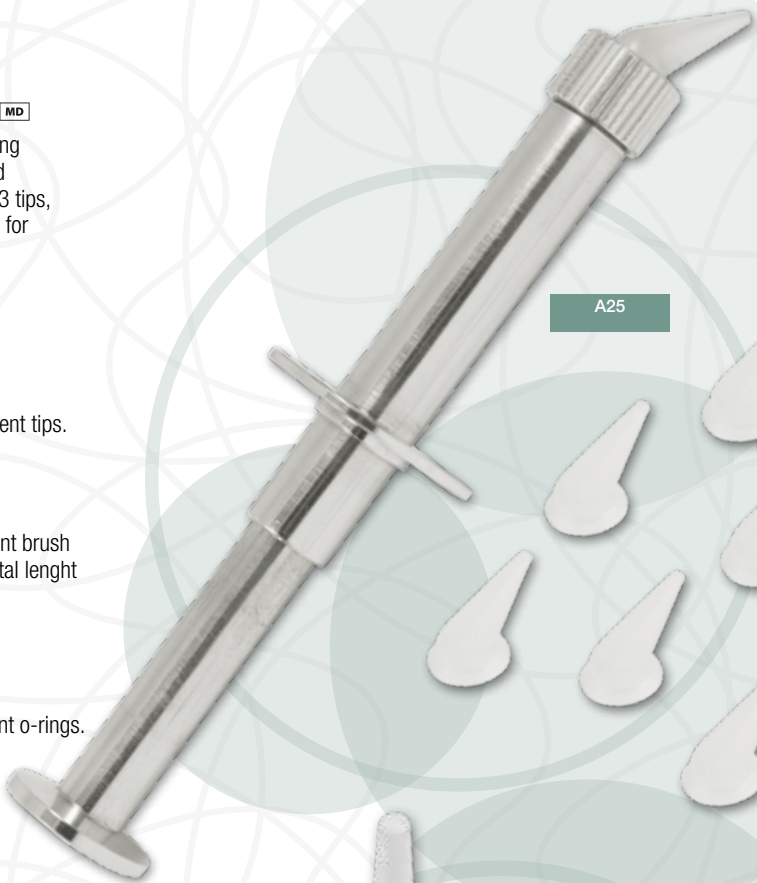

A25

A25.1

Set 10 replacement tips.



A25.2

Nylon replacement brush cm 5,5 ø 1,2. Total length cm 13.

A25.3

Set 5 replacement o-rings.

A27

Disposable elastomer plastic syringe, adjustable tip, 5 cc, package 50 pcs.

 cm 13 ø2

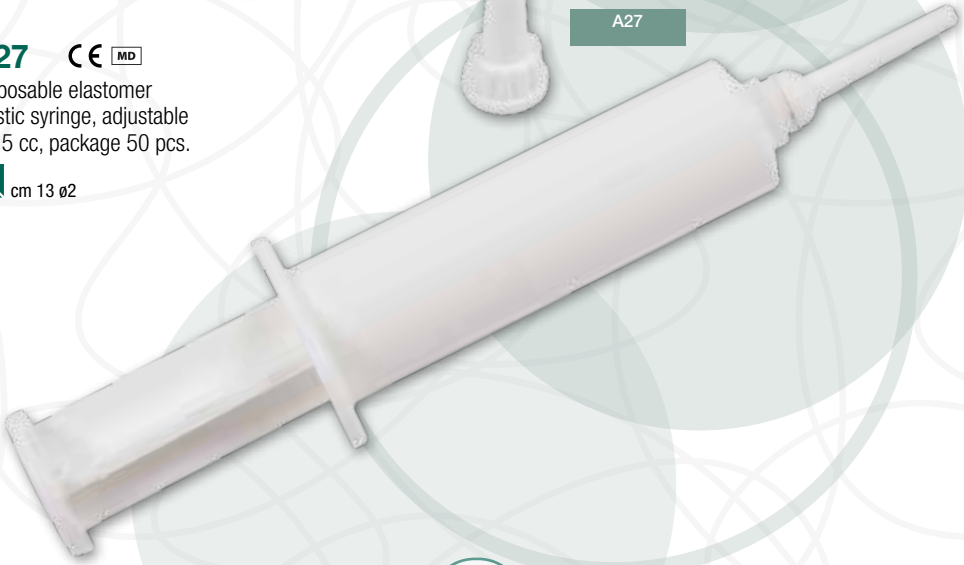

A27

SYRINGES



C80 CE MD

Disposable Luer syringe
2.5 ml, needle 25 Gauge
blunt needle, package pcs.
100, 0,5x30 mm.

C80

C81

C81 CE MD

Disposable Luer lock
syringe 5 cc without
needle pcs 100.

C82 CE MD

Disposable Luer lock
needle 25 Gauge, blunt
needle, package pcs 100.

Flat headed needle
for easy and safe
insertion into tooth
canals.



C82

**STERILE
IN BLISTER**

C85

C86

C84 CE MD

Disposable syringe with
needle, 2.5 cc, 100 pcs.

C85 CE MD

Disposable syringe with
needle, 5 cc, 100 pcs.

C86 CE MD

Disposable syringe with
needle, 10 cc, 100 pcs.

C87

C84

C87 CE MD

Disposable syringe without
needle, 5 cc, 100 pcs.



CONSERVATIVE

C35



C35

Disposable mixing pots, 50 pcs.

cm 7x5,5

R24



R11

R11

Disposable mixing spatulas, 100 pcs.

cm 13

CM 0,8 PUNTA

LUNGHEZZA PUNTA CM 5,8

CM 1,2 BASE

R24

Plastic polyamide spatula for cement and acrylic, autoclavable, 100 pcs.

cm 18,5

R16

Dappen pots sterilizable 4 cavities with orange color cover for UV protection. Package 5 bases and 1 orange cover.

Base cm 5x5
Dappen pots cm ø1,9



R16



V41

Glass mixing slab, double thickness, cm 15x7 h 1

V42

Glass mixing slab, cm 15x7 h 0,5

V43

Glass mixing slab, cm 7x7 h 0,5



V45

V44

Glass mixing slab, cm 9,5x7 h 0,5

V45

Glass mixing slab, cm 12,5x7 h 0,5



Plastic mixing pad, anti-slip base, thickness 0.14 mm.

100 sheets each

C10

6 pcs, cm 5x5

C11

6 pcs, cm 8x8

C12

3 pcs, cm 14x8

50 sheets each

C13

3 pcs, cm 14x20



Personalizable, size or cover, for a cheap and welcome opportunity to promote your brand name.

Paper plastified mixing pad, anti-slip base, thickness 0.12 mm.



100 sheets each

C16

6 pcs, cm 5x5

C17

6 pcs, cm 10x10

C18

3 pcs, cm 12x18

50 sheets each

C19

3 pcs, cm 15x24



CONSERVATIVE

Composite brushes, white or black, in different sizes. Made of polyamide, in bags 100 pcs.

C31 CE MD

Extra fine white

C32 CE MD

Fine white

C33 CE MD

Extra fine black

C34 CE MD

Fine black

Class I Medical Devices.

C36 CE MD

Composite brushes kit with 6 handles and 400 brushes (100 for each size) in sturdy plastic (total 400 pcs).

cm 17x14 h4



C36

C30 CE MD

Autoclavable plastic handle, assorted 3 pcs (1 each of Light blue, white and green).

C30

Junior cup RA 100 pcs.

Junior cup RA 10 pcs.

C45 CE MD

White bristle

C45.10 CE MD

White bristle

C46 CE MD

Nylon

C46.10 CE MD

Nylon

C47 CE MD

Skirt shaped rubber cup for right angles.

C47.10 CE MD

Skirt shaped rubber cup for right angles.

C45



C46



Class IIA Medical Devices.

C47





C90

C92

Sterilizable sponges in polyurethane, autoclavable up to 134°. Packed in a dispenser type box with protective cellophane to guarantee hygiene and its white colour. Certified as a medical device Certificate Class I.

C90 CE MD
Endodontic sponges, 50 pcs.

cm ø5 h0,5

C92 CE MD
Endodontic sponges, 25 pcs.

cm ø5 h1

C95 CE MD
Introduction endoclean sponges kit: 3 autoclavable supports, 50 sponges cm 0.5 thick, 25 sponges cm 1.

C99 CE MD
Endodontic sponges, 25 pcs. For endostand G44.

cm ø6,5 h1



G44

G44 CE MD
Autoclavable endostand, for sponges (C99).

AVAILABLE COLORS: Ne

cm 6x4 h5



Q28



G29

G29 CE MD
Autoclavable plastic holder for endodontic sponges, closed base.

AVAILABLE COLORS: Bl Ro Ve
cm ø4,5 h3

Aluminium endodontic instrument cleaner.

Q25 CE MD
Open base

Q28 CE MD
Closed base

cm ø4 h3,2



COTTON HOLDERS

Pellets dispenser with spring.

A20.1
Small hole autoclavable.

cm 5x5 h5,3

A20.2
Medium hole autoclavable.

cm 5x5 h5,3

A20.3
Large hole autoclavable.

cm 5x5 h5,3

A20.5
Stainless steel, medium hole.

cm 5x5 h5,3

L4
Cotton roll holder, plastic, with 4 compartments.

cm \varnothing 12,4 h5

F17
Metallic tweezers.



F17



L2

L4

L5

Plastic cotton holder, stainless steel lid.



L1 cm \varnothing 10 h10
Small

L2 cm \varnothing 10 h12
Medium

L3 cm \varnothing 12 h12
Large

Hinged lid on request.



L5
Metal cotton holder, with spring.

cm \varnothing 6,3 h8,2



COTTON ROLL CONTAINERS

A42

A42

Cotton roll container, for injection control. Sterilizable at 121°. Made in anti bacterial material. Universal for rolls 1, 2, 3. Capacity 50 rolls. Each piece dispensed individually.

AVAILABLE COLORS:



cm 10,5x5 h10



Cotton wool roll container fully autoclavable at 121° (including the transparent part). The cotton wool roll comes out of the container by pressing lightly on the lid. Excellent solution to prevent cross infections.

PP/M BACTERIOSTATIC

Plastics with bacteriostatic treatment. Prevents the growth of micro organisms and creation of bad smell.

A4

Cotton roll dispenser, capacity of 50 rolls.

AVAILABLE COLORS:



cm 9,5x5 h10



A4

A45

A45

Cotton roll dispenser, for an optimal infection control. Each piece dispensed individually.

AVAILABLE COLORS:



cm 6x14 h15



A47



A48



A47 CE MD

Sterilizable metal double cotton clip holder, packaging 4 pcs.

A48 CE MD

Cotton clip, double cotton roll holder in plastic, packaging 100 pcs.



GLOVE CONTAINERS

G13

Glove dispenser, plastic, to be mounted on the wall.

AVAILABLE COLORS: Bi

 cm 28x10,5 h6,5



G13



G16

G16

Glove dispenser, plastic, to be mounted on the wall.

AVAILABLE COLORS: Bi

 cm 26,5x14 h14

G19

Glove dispenser, transparent plexiglass, to be mounted on the wall.

 cm 25x8 h13,5



G19



A10

A10

Plastic double dispenser
for gauzes cm 5x5,
autoclavable 134°.



cm 11,6x6,5 h8

A34

Paper towels dispenser.

AVAILABLE COLORS:



cm 18x13 h17



A34

A37

Plexiglass mask dispenser.



cm 20,2x12 h11

A37



ORGANIZERS

G58

Round rack for 19 dental pliers, acrylic.

 cm 20x13 h10

G58



G56



G56

Holder for 10 dental pliers or scissors, acrylic, white color.

 cm 21x20 h6,5

G81

G81

Round dental pliers holder, with instrument holder in the centre.

 cm ø12 h12



Available without central instrument holder (Code: G59).

G87



G91



G87

Holder for dental pliers and instruments.

 cm 26,5x10,5 h11

G91

Dental plier holder.

 cm 22x8 h14



G50

Plexiglass archwire holder,
10 separate positions.

cm 19,5x9,5
h base 2,5 cm



G50

G57



G57

Archwire holder with cover,
stores 12 separate sizes,
acrylic.

cm 20x10 h11

G85

Organizer for fastenings
with cover.

cm 17x22 h14



G85

G86



G86

Combined organizer with
cover.

cm 17x22 h14

G90

Organizer for small elastic
chains with cover.

cm 24,5x9,5 h9,5



G90



ORTHODONTICS

cm 8,7x6,5

cm 10x7,7

G2.2



cm 8x5,7

G2.3

cm 8,7x6,8



cm 7,5x5,7

G2.1

Orthodontic rubber impression trays, 5 pcs (3 sup. + 2 inf.).

G2.1
Smooth surface

G2.2
With horizontally lined surface.

G2.3
With vertically lined surface.



Plastic model trimmers, 200 pcs (100+100).

G28

G28
Plastic Model Trimmers pcs 200 (100 + 100). Anatomically shaped edges.

 cm 6x8,2 h6

See page 113 for other product shapes and measurements.



A2

Adult size cheek retractors, available in pairs.



A2

A3

Child size cheek retractors available in pairs.



A3

Ideal for dental photographs inside the mouth because they do not reflect.

Sterilize up to 121°C. No contact with metallic instruments.

A8

Cheek retractors with long handles adult size, in pairs, autoclavable.

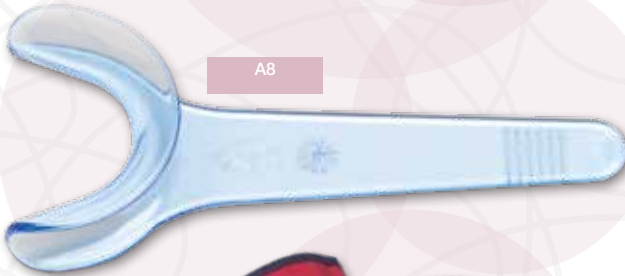

A8

A9

Cheek retractors with long handles child size, in pairs, autoclavable.

G71

Envelopes for arched face bows, deluxe model, in special corduroy material, reinforced edges, velcro closure, package with 10 pcs, assorted colours.

cm 22x10



G71



F35

F35

Blue, metallic orthodontic tweezer holder.

cm 15x10 h11



ORTHODONTICS

Model boxes for orthodontics, paradontology and implantology. Made of break-resistant ps plastic, with handle, up to 5 models.

AVAILABLE COLORS: ● ● ● ● cm 10x34 h8

G92

Without handle.



G92

G94

With handle.



G94

G95

Plastic blue rack with two orthodontic containers type G94. Stackable and/or possible to place along side each other, structuring as well as possible the organisation of the models.

AVAILABLE COLORS:



cm 20,5x34,5 h9



G95



G97



G97

Carton container for orthodontics and implantology.

AVAILABLE COLORS:



cm 21x32 h6



G1-MISTO

Package with 6 assorted colours prosthesis boxes.

G1



G4

G1

Prosthesis box with internal filter, white colour, autoclavable, packed individually in plastic bag.

AVAILABLE COLORS:



STANDARD CARTON 150 PCS

16 cartoni h 220
2400 pz tot

12 cartoni h 170
1800 pz tot

cm ø9 h8,2

G4

Prosthesis box with internal filter, white colour, autoclavable, packed individually in paper box.

GAMMA COLOR: Bi

cm ø9 h8,2

G68

G68

Box with internal rubber separation. Package 10 pcs.

AVAILABLE COLORS: Bi

cm 9x9 h5





ORTHODONTICS

G3 DELUXE

Package with 20 orthodontic boxes in glittery colours, with cord, in carton for easy stockage and presentation.



G3 DELUXE



The original, concerning shape and dimensions. Created in 1990, in collaboration with two genoise dentists. Since then many people have tried to copy us. Result? They copy the shape but not the quality. They are made of specific Polypropylene, the safest material for one's health because it's hypoallergenic and non toxic. They are indestructible because we heat the hinge of each container while putting it in place, for perfect resistance.

G20

Coloured cord for orthobox, 10 pcs, assorted colors.

AVAILABLE COLORS:



Az Fu Gi Ve



G3 GLITTER

G3 GLITTER

Prosthetic and orthodontic boxes in glittery colours, making a metallic and marble effect, giving the product a more modern and attractive look. Bag 10 pcs.

AVAILABLE COLORS:





G3

Orthodontic box with ventilation, holes for cord, various colors, also available in assorted packaging. Package 10 pcs.

STANDARD CARTON 250 PCS (25 BAGS)

AVAILABLE COLORS:

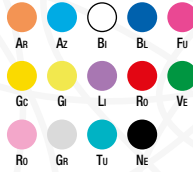

16 cartoni h 220
400 cf da 10 pz

12 cartoni h 170
300 cf da 10 pz

cm 8,3x8,4 h4,4
h interna 4 cm



G3

THE ORIGINAL

THE CHEAPEST

G37

Light orthodontic box, economic model, modern design, with ventilation holes, 10 pcs per packaging.

AVAILABLE COLORS:



STANDARD CARTON 350 PCS (35 BAGS)

16 cartoni h 220
180 kg

12 cartoni h 170
140 kg

cm 8,1x7,5 h3,8
h interna 3,4 cm



G37



ORTHODONTICS

G78

Orthobox <<special box>> with ventilation holes, pcs 10.

AVAILABLE COLORS:  Az
 cm 8,5x6,5 h4



G78

PP/M BACTERIOSTATIC

Plastics with bacteriostatic treatment. Prevents the growth of micro organisms and creation of bad smell.

G79

<<anatomical>> orthobox with ventilation holes, pcs 10.

AVAILABLE COLORS:  Az
 cm 8x7 h4



G79

G64

Orthobox in sturdy plastic for removable orthodontic braces, with ventilation holes, 10 pcs per packaging.

AVAILABLE COLORS:  Az  Bi  Ve  Fu  Gi

 cm 5,5x7,5 h4



G64



G76

G76

Orthobox with mirror, light blue color. Package 10 pcs.

 cm 8,5x6,5 h4,2



G45

Small retainer box (for bite) with ventilation holes, various colors, also available in assorted packaging. Package 10 pcs.

AVAILABLE COLORS:

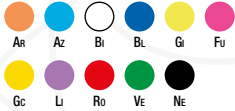

STANDARD CARTON 500 PCS (50 BAGS)



16 cartoni h 220
800 cf da 10 pz



12 cartoni h 170
600 cf da 10 pz



cm 7,8x7,3 h2,5

G45

THE MOST SOLD



G45 GLITTER

Small retainer boxes in glittery colours, making a metallic and marble effect, giving the product a more modern and attractive look. Bag 10 pcs.

AVAILABLE COLORS:

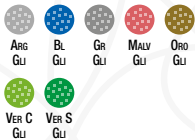

G45 GLITTER

G45 DELUXE

Package with 20 bite boxes in glittery colours, in carton for easy stockage and presentation.



G45 DELUXE





ORTHODONTICS

G46

G46

Small retainer box (for bite) without holes, various colors. Package 10 pcs.

AVAILABLE COLORS:



STANDARD CARTON 450 PCS (45 BAGS)

16 cartoni h 220 720 cf da 10 pz 12 cartoni h 170 540 cf da 10 pz

cm 7,8x7,7 h3
h interna 2,8 cm



G49

G49

Small retainer box (for bite) with holes, various colors. Package 10 pcs.

AVAILABLE COLORS:



STANDARD CARTON 450 PCS (45 BAGS)

16 cartoni h 220 720 cf da 10 pz 12 cartoni h 170 540 cf da 10 pz

cm 7,8x7,7 h3
h interna 2,8 cm

G47

Double bite box, white color. Package 10 pcs.

STANDARD CARTON 450 PCS (45 BAGS)

16 cartoni h 220 260 kg 12 cartoni h 170 200 kg

cm 10,5x7,5 h2



G47



G43

Small retainer box (for bite) with ventilation holes various colours, with hole for cord. Available in 12 different colours.

AVAILABLE COLORS:



16 cartoni h 220
720 cf da 10 pz

12 cartoni h 170
540 cf da 10 pz

cm 8,4x8,3 h2,5



G43

NEW

Ideal for aligner use.



G48

G48

Small retainer box (for bite) with ventilation holes various colours, with hole for cord. Available in 12 different colours. With mirror.

AVAILABLE COLORS:



cm 8,4x8,3 h2,5



ALIGNER CASES

G340

Aligner box with a lid that snaps shut. Available in various 2 colour combinations. 2 aligners can fit into it easily.

AVAILABLE COLORS:

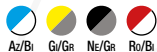

 cm 10x7,6 h2



G340



G342

G342

Aligner box with a lid that snaps shut. Available in various 2 colour combinations, with a place for the chewie and extraction hook.

AVAILABLE COLORS:



 cm 10x7,6 h2

G345

Aligner box with a lid that snaps shut. Available in various 2 colour combinations, with a mirror and a place for the chewie and extraction hook.

AVAILABLE COLORS:



 cm 10x7,6 h2

G345





N60

N70

FEATURES

Very large **well for beads**.

Clamping plate compatible with square and round sheets.

Energy saving and safety device.

Enough space for tall plaster models.

Accessibility to the plaster model during the heating process.

Electrical resistance: Power supply 230V - Absorption 1,4 A - Power 325 WAC

Vacuum pump: Frequency 50 Hz - Nominal flow 12l/min.

N60 CE

COMPLETELY MANUAL MODEL COMPATIBLE WITH ANY TYPE OF THERMOPLASTIC PLATES

Elegant front control panel.

Manual control of the heating time of the sheet.

Manual drive of the locking plate.

Dimension: W24 x D28 x H33 cm

Weight: 5,5 Kg.

TERMOFORM®

N70 CE

FULLY AUTOMATIC MODEL FOR AN EXCELLENT RESULT

Color LCD display

Machine performs automatically the thermoforming process without any operator intervention.

Thermoforming creates fully automatic products in a short time.

TECHNICAL FEATURES:

Electrical resistance: Power supply 230V - Absorption 1,4 A - Power 325 WAC

Vacuum pump: Frequency 50 Hz - Nominal flow 12l/min. - Final pressure (ASS) 250 mbar - Noise with silencer 56 dB(A) - Motor power 80 W - Absorption 0,9 A

Gearmotor: Power supply 24V C.C. - Absorption 0,6 A - Power 12 W

Dimension: W24 x D28 x H33 cm

Weight: 6,5 Kg



TERMOFORM®

GHOST ALIGNER CE MD

Special material, transparent and elastic, that allows creating a dental aligner that produces a delicate strength and therefore more constant. Great elasticity that optimizes bite adaptation to dental morphology, attachment, and interdental spaces obtaining excellent results. A better adhesion allows a more stable contact point and also a more constant strength and therefore a more precise teeth movement. More comfort and better ease of insertion and removal. It shapes and finishes easily. Package 20 pcs.

FORMATS AVAILABLE: square 12,5 x 12,5 cm, round ø 12 cm, ø 12,5 cm.



RIGIDO - VERY HARD

Square	ø120 mm	ø125 mm	Thickness	pz
N910	N920	N930	0,5 mm	20
N911	N921	N931	0,75 mm	20
N912	N922	N932	1 mm	20

The aligners built with **GHOST ALIGNER** do not interfere with aesthetics, phonetics and do not cause any discomfort to the gums and teeth of patients.

DUAL LAMINATES CE MD

Double layer disks: upper side is hard and lower side is soft.

APPLICATIONS: bruxism bites, A.T.M. bites, orthodontic applications.

FORMATS AVAILABLE: square 12,5 x 12,5 cm, round ø 12 cm, ø 12,5 cm.

Packagings with 12 pcs.



N518

Filling for the pot. Pck 450 gr.



N619

Sanitizing detergent gel with mint flavour specific for daily hygiene of transparent aligners, bite, mobile devices and dental prosthesis. Bottle hygiene 100 ml.



DUAL LAMINATES

Square	ø120 mm	ø125 mm	Thickness
N410	N420	N430	2 mm
N411	N421	N431	3 mm
N412	N422	N432	5 mm



TERMOFORM®

EVA SOFT

Soft and clear discs in EVA. Easy to shape and finish.

APPLICATIONS: whitening bytes, fluoride prophylaxis bytes, bruxism bytes, A.T.M. bytes, plaster model duplication.

FORMATS AVAILABLE: square 12,5 x 12,5 cm, round ø 12 cm, ø 12,5 cm.

EVA SOFT: Transparent soft disc made with Ethylene vinyl acetate (EVA).

Frame the QR code to download the instructions for use of the thermoplastic discs.



SPLINT

Very hard sheet with high transparency, protected by a thin film on both sides. Produced with special blends that prevent the formation of air bubbles during the heating process.

APPLICATIONS: hard bleaching bytes, hard bruxism bytes, temporary matrices, surgical spoons, lingual splint plates, restraint and protective splint, invisible retainers, dental bridges and crowns, orthodontic applications.

FORMATS AVAILABLE: square 12,5 x 12,5 cm, round ø 12 cm, ø 12,5 cm.

SPLINT: Hard disc with excellent transparency, produced with resins (PET-G) that limit the formation of bubbles during heating. It can be applied on top of the resin.

SOFT

Square	ø120 mm	ø125 mm	Thickness	pz
N612	N622	N632	1 mm	25
N613	N623	N633	1,5mm	25
N614	N624	N634	2 mm	24
N615	N625	N635	3 mm	25
N616	-	-	4 mm	20

SOFT

Square	ø120 mm	ø125 mm	Thickness	pz
N612-10	N622-10	N632-10	1 mm	10
N613-10	N623-10	N633-10	1,5 mm	10
N614-10	N624-10	N634-10	2 mm	10
N615-10	N625-10	N635-10	3 mm	10
N616-10	-	-	4 mm	10

VERY HARD

Square	ø120 mm	ø125 mm	Thickness	pz
N710	N720	N730	0,5 mm	25
N711	N721	N731	0,75 mm	25
N712	N722	N732	1 mm	25
N713	N723	N733	1,5 mm	25
N714	N724	N734	2 mm	20
N715	-	-	3 mm	20

VERY HARD

Square	ø120 mm	ø125 mm	Thickness	pz
N710-10	N720-10	N730-10	0,5 mm	10
N711-10	N721-10	N731-10	0,75 mm	10
N712-10	N722-10	N732-10	1 mm	10
N713-10	N723-10	N733-10	1,5 mm	10
N714-10	N724-10	N734-10	2 mm	10
N715-10	-	-	3 mm	10



IMPLANTOLOGY

LT-1

Universal bur holder for FG and RA or implant burs. Contains 24 tips. With rubbers to block the tip. Max height burs 37 mm. Autoclavable at 121°. Transparent autoclavable lid.

AVAILABLE COLORS: Az/Ne Ro/Ga

cm 6,3x4,5 h3,4
h interna da base 1,9 cm



LT-1

LT-2

Universal bur holder for implantology tips and/or scalers. Contains 24 tips. With rubbers to block the tip. Max height burs 45 mm. Autoclavable at 121°. Transparent autoclavable lid.

AVAILABLE COLORS: Az/Ne Ro/Ga

cm 6,3x4,5 h5
h interna da base 3,5 cm



LT-2

L85

Implantology bur holder, high burs, autoclavable plastic.

L88

Implantology bur holder, low burs, autoclavable plastic.



L88

L85

CM 4,8
INTERNA CM 3,5
 CM 3,5
INTERNA CM 2,5



A6 CE MD

Four plastic implant instruments, autoclavable.

A6

N°4



N°2



N°1



N°3



A00406 CE MD

Scalers.

A00406



S5

Stainless steel implant tray organizer, with 16 removable containers for screws 4.5x1.5 cm and 2 containers for instruments 17.5x3.5 cm and 9.5x2.5 cm with double cover.

 cm 21x10,5 h3

S5





MOUTHWASH

SPDD® (DENTAL DYSCROMIA PROTECTION SYSTEM)

Mouthwash Chlorhexidine 0.20% contains the innovative SPDD®, a system specifically designed to help and prevent dental dyschromia that can be caused by normal chlorhexidine treatments.

F68



F68

5 litre bottle, in a single cardboard box.

F68.DISPENSER

Dispenser for the 5 litre bottle.



F66

Cardboard box with 6 bottles of 1 l, 1 dispenser included.

F66.DISPENSER

Dispenser for the 1 litre bottle.



F66

Chlorhexidine 0,20%

Mouthwash with 0.20% Chlorhexidine. Chlorhexidine is the chosen active ingredient for sanitizing and avoiding bacterial proliferation in the mouth and it destroys plaque, acting positively where gum and periodontal problems occur.

The 0.20% chlorhexidine concentration is particularly suitable for intense anti-plaque treatment: in particular before and after any dental treatment, problems with periodontal diseases and/or gum disease and for those who wears prosthesis and dental braces.



MT **CE** **MD**

Single use impression tray, made of non-toxic PVC. Cold sterilizable. Used for polyesters, silicones, elastomers, alginates (using a specific adhesive). Applications /indications: dental use, in the oral cavity. Available in three different dimensions, superior and inferior. Packaging with 6 pcs, assorted or per size.



MT

UPPER

MT1SUP	U3	SMALL	69	55
MT2SUP	U4	MEDIUM	72	60
MT3SUP	U5	LARGE	77	67

LOWER

MT1INF	L3	SMALL	77	50
MT2INF	L4	MEDIUM	82	55
MT3INF	L5	LARGE	85	62

Frame the QR code for the video tutorial.



APPLICATION TRAY

Double fluoride applicators made of light and flexible plastic. Double spoon for jaw fluoride applications, above and below, at the same time. Colour coded yellow, blue or green so that each applied gel is visible. Latex-free. Pack of 50 pieces

CE **MD**



PP-620 Green, small

PP-621 Yellow, medium

PP-622 Blue, large

PP-620

PP-621

PP-622



IMPRESSION TRAYS

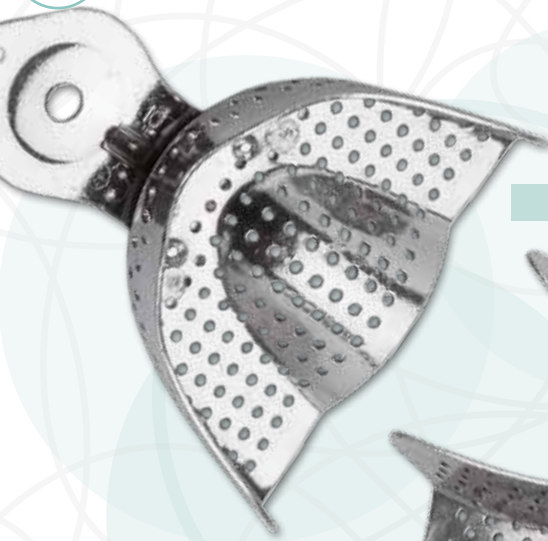

MA

MA

Alluminium perforated impression trays.

MA1

Alluminium perforated impression trays. Set 12 pcs.

UP.	0	1	2	3	4	5
	63	69	72	74	75	83
	44	47	48	50	53	58

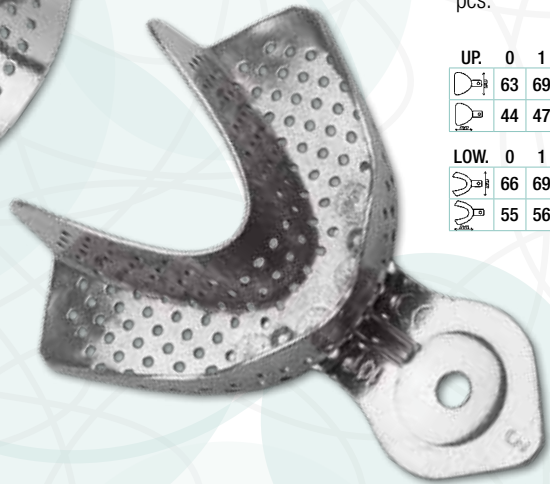

MD

MD

Partially perforated alluminium impression tray.
Sizes: 1-3-5 / SX - DX.



ME



ME

Partially perforated inox impression tray.
1-3-5 / SX - DX.







MR



MR  
 Perforated stainless steel impression trays with retention rim.



MR1  
 Perforated stainless steel impression trays with retention rim set 12 pz.

UP.	0	1	2	3	4	5
	66	67	68	72	73	74
	50	51	55	56	59	64

LOW.	0	1	2	3	4	5
	68	70	72	78	79	80
	52	54	56	57	59	63

MS



MS  
 Stainless steel perforated impression trays.

MS1  
 Stainless steel perforated impression trays set 12 pcs.

MB  
 Stainless steel flat surface impression trays with retention rim.

MB1  
 Stainless steel flat surface impression trays with retention rim set 12 pcs.



ML  
 Stainless steel flat surface impression trays.

ML1  
 Stainless steel flat surface impression trays set 12 pcs.

MB



DISINFECTION

G80

Plastic autoclavable instrument container with non-slip support.

AVAILABLE COLORS:



 cm 18,8x9 h2,4

G80



G41

Autoclavable silicone mat for instruments, with different distances between the pins (0,8 cm x 1 cm).

 cm 28x18

G41





G11

G11

Sterilization box for dental instruments, fits 1.250 lt.

 cm 26x11 h8



G11.1

Container for sterilizing burs and small instruments.



G11.1

S3

Stainless steel box with internal filter for bur disinfection.

 cm ø9 h5



S3

G5

Sterilizable box for bur disinfection with internal filter.

 cm ø9 h8,2



G5





MQ-1

M-arsupio, the transparent plastic bag ideal for transporting and storing impression trays and models. The hermetic closure guarantees the protection of the product from external agents. The external pocket is useful for storing the patient's notes. On the opposite side, the white label that can be written on is intended for the specification of personal data. Size of bag 18x25 cm. Upper edge 2 cm. Pocket 18x20 cm. Pack=100 pcs.

 cm 27x18



MQ-1

F43

Clean Tray neutral pH dissolved in water forms a neutral solution which removes easily and quickly alginate from trays and other instruments. 1Kg.



F43



G70

Box for cold sterilization,
autoclavable at 121°, fits
3 lt.

AVAILABLE COLORS:



 cm 35x26 h14

G70



T33

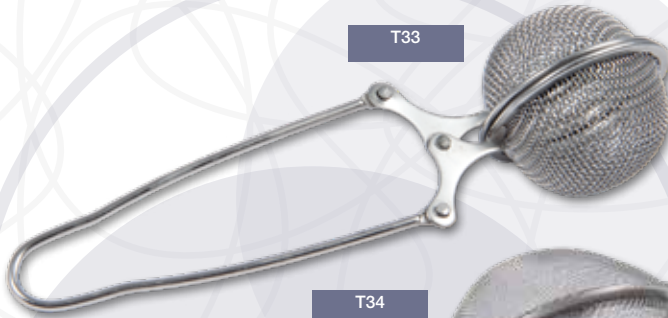

T33

Stainless steel plier for
burs.

 cm 14,5 ø3,5

T34



T34

Stainless steel plier for
burs.

 cm 17 ø5,5



TURBINE ACCESSORIES

A5

Turboclean, a container sterilizable at 134° for dripping off liquids from turbine, handpieces, micromotors, with 8 holes and 5 absorbing discs.

 cm ø12 h12



A5

A51

Absorbent discs, refills for Turboclean, packaging with 20 pcs.



VISTA INTERNA
INTERNAL VIEW

A57

Turbonet handpieces cleaning system.

 cm 6,2x6,2 h8



A57

A57.1

Set of 8 replacement brushes for Turbonet.



F49

Handpiece spray. Cleans straight and contra-angle handpieces, turbines, heads and air motors. Free of resin and acid, sterilization resistant. 500 ml

 master carton:
12 pz

 cm 6,2x6,2 h8

Handpiece spray is always used before sterilization. We recommend spraying the instruments a few seconds after attaching the adapter by pressing the spray head one or more times.



F49





F30

Synthetic spray that upgrades the presentation of your models. Glossy with mint odour. Easy to utilize. Bottle 75 ml.

 *master carton:*
20 pz



F30

Creates a protective layer on the prosthesis that guarantees a pleasant sensation/taste in the patient's mouth. If sprayed inside a container it eliminates bad smells.

F32

F32  

Occlusion spray, leaving an ultra thin and homogenous layer of powder. Excellent adhesion to all prosthesis materials. Dry and easily removable with water. Big bottle, 200 ml. For extra oral use in the dental laboratory. Spray 200ml green color + canula.

 *master carton:*
12 pz



Particles with a new composition in order to get certification as a medical device. The old particles were nothing else but finely grinded plastic. To keep the official CE marking we use new particles that are safe for food. Over 500 seconds of spray per 200 ml can.

F41

Scan'spray lab is used to achieve optimum recordings. for cad/cam restorations. Scan'spray lab balances out the different optical properties of the plaster model and permits optimum recording using a scanner. Within a moment you can spray an optimal covering layer with a detailed representation of the edges. 200 ml.

 *master carton:*
12 pz



F41

It evaporates instantly for immediate visual inspection and quick usage. Guaranteed a layer of fine, homogeneous powder.

R22

R22  

Ice spray (-50°C), 200 ml container, non-toxic and cfc-free.

 *master carton:*
12 pz



Useful for cooling off hydrocolloid type impression materials and glass plates. The plastic cannula can be used for more precise spraying, while direct spraying is recommended for impression pastes.



ALUMINIUM TRAYS

Q17

Anodized aluminium tray, medium.

AVAILABLE COLORS:



 cm 18x14 h1,5

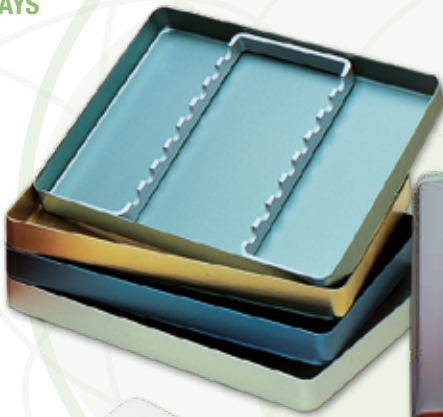

Q17



Q17.1

Alluminium cover for Q17, silver color.

Q24

Rack for 8 instruments.



Q31

Anodized aluminium tray, set with tray (Q17) + cover (Q17.1) + rack for 8 struments (Q24).

AVAILABLE COLORS:



Q177

Q177

Alluminium mini tray rack, 6 levels, for Q17.

 cm h28

Q34

Perforated tray, medium.

AVAILABLE COLORS:



 cm 18x14 h1,5



Q34.1

Q34.1

Cover for perforated alluminium tray.





ALUMINIUM TRAYS

Q16

Anodized aluminium tray, large.

AVAILABLE COLORS:



 cm 28,4x18,3 h1,7



Q16

Q16.1

Aluminium cover for Q16, also for plastic trays, silver colour.

Q19

Rack 11 instruments.

Q20

Rack 17 instruments.

Q30

Anodized aluminium tray (Q16)+ cover (Q16.1) + rack (Q19).

AVAILABLE COLORS:



Q166

Aluminium maxi tray rack, 6 levels, for Q16.

 cm h28

Q166

Q32

Perforated tray, large.

AVAILABLE COLORS:



 cm 28,4x18,3 h1,7

Q32.1

Perforated cover for Q32, only silver color.

Q33

Anodized aluminium tray, set with tray (Q32) + cover (Q32.1) + rack for 17 struments (Q20).

AVAILABLE COLORS:



Q32



INOX TRAYS

S1

Stainless steel kidney shaped dish.

 cm 25x13,5 h3,5



S1

Ideal stands for disposable trays C51 and C52.



S14

S14

Small stainless steel container/tray.

 cm 20x10



S15

S15

Large stainless steel container/tray.

 cm 20x15

S16

Stainless steel instrument tray.

 cm 28,4x18,3 h1,7

S16.1

Lid for tray S16.



S16

S19

Inox rack for 11 instruments for tray S16.



G7

Plastic tray without rack.







AVAILABLE COLORS:  Bi

G8

G8

Plastic tray with rack, cold sterilizable.

AVAILABLE COLORS:

 Az  Bi  Gi
 Gr  Ro  Ve

 cm 28,4x18,3 h1,7



Q22

Disposable dappen dishes for trays, assorted colors 200 pcs.

AVAILABLE COLORS:

 Az  Bi  Gi  Ro  Ve

Q22

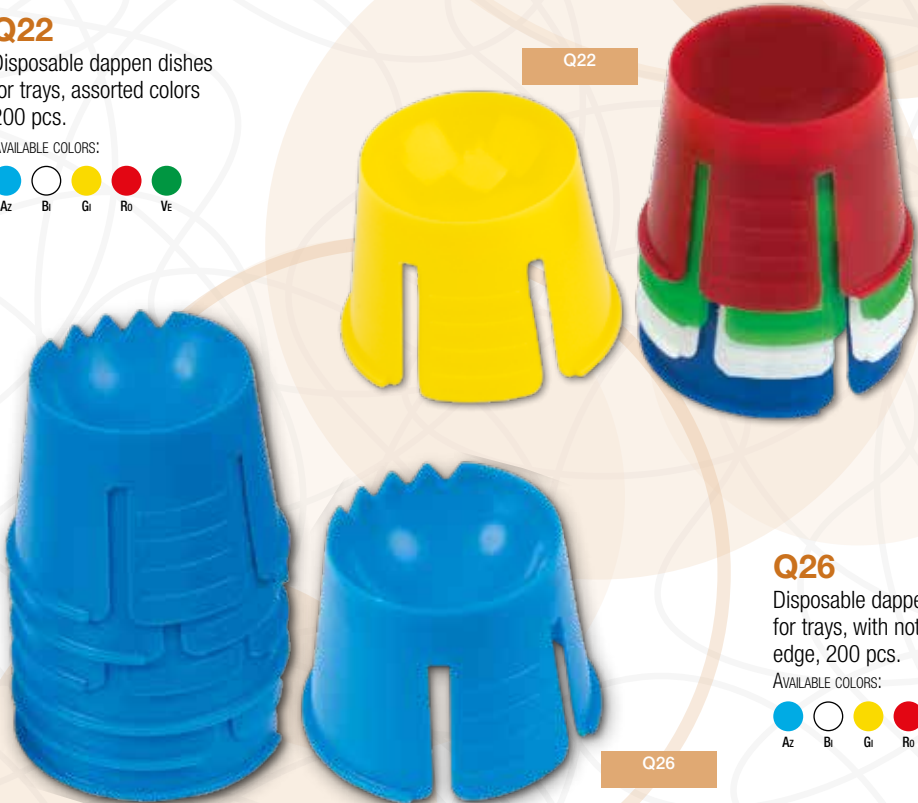

Q26

Disposable dappen dishes for trays, with notched edge, 200 pcs.

AVAILABLE COLORS:

 Az  Bi  Gi  Ro  Ve

Q26



ORGANIZERS



G63

G63

Organizer for dental cabinet. The base is composed of:

- Holder for composite syringes (code G53.1)
- 1 bur disinfection holder (code G5)
- 2 bur holders 72 holes FG, with transparent cover (code LS72FG)
- 3 bur holders 36 holes FG, with transparent cover (code LS36FG)
- 1 paper mixing pad 5x5 cm (code C16)
- 1 petri dish diam. cm 6 (code V31)
- 1 mixing pot (code C35)
- 3 glass kappens (ns cod V1)
- 2 glass dappens (ns cod V2)
- 1 petri dish diam. cm 6 (code V31)
- 1 mixing pot (code C35)
- 3 glass kappens (ns cod V1)
- 2 glass dappens (ns cod V2)

 cm 42x32x11

G51

Organizer for dental cabinet. The base is composed of:

- 1 plastic instrument container (code G11)
- 1 bur disinfection holder (code G5)
- 4 bur holders 72 holes FG, with transparent cover (code LS72FG)
- 1 paper mixing pad 5x5 cm (code C16)
- 1 petri dish diam. cm 6 (code V31)
- 1 mixing pot (code C35)
- 3 glass kappens (ns cod V1)
- 2 glass dappens (ns cod V2)

 cm 42x32x11

G51



COMPOSITE SYRINGES CONTAINERS



G53

G53

Plexiglass organizer with 24 holes for syringes, standard hole 1,8 cm.

 cm 22x10 h11

G54

Plexiglass organizer with 12 holes for syringes, standard hole 1,8 cm.

 cm 12,5x10 h11



G55

G55

Plexiglass organizer with 12 holes for syringes, 3 small compartments and 2 medium containers. Back row hole \varnothing 1,8 cm, front row hole \varnothing 1,4 cm.

 cm 22x10 h11



G84



G83

G83

Plexiglass organizer with 18 holes for syringes, with holes for Voco style syringes.

 cm 22x11

G84

Plexiglass organizer with 12 holes for syringes, with holes for Flow tetric style syringes.

 cm 12x12



SAFETY BOXES

G62 2LT CE

Excellent stability with the use of a suction cup. Easy snap assembly system, practical opening system. Release notches for needles and insulin pens. Wide opening for the removal of bulky objects. Indicator for maximum level of filling. No emission of harmful gases during incineration. Temporary and final closure. Various types of holders available. Package pcs 10. Capacity 2lt each.

 cm ø9,8 h22

G62



G73

G73

Suction plate for G62, with a non-slip suction cup base.

 cm 14x11,5



G12

G12 CE

Pocket version. Ergonomic and easy to use with one hand. Double opening system: unhooking of needles and insulin pens and disposal of complete syringe. Possible side hooking. Packaging 5 pcs.

 cm 8,5x16





G72

Disposable container box for special waste and used needles, lid cannot be reopened, to be sealed after use. Defluxion flow wings to prevent waste escaping. Mechanism for insulin needles. Indication of maximum filling level. No harmful gas emission during incineration. Provisional and definitive closure.

**G72 0,7LT CE**

Excellent stability with the use of a suction cup. Easy snap into place assembly system, practical opening system. Notches unhooking needles and insulin pens. Wide opening for the removal of bulky objects. Indicator for maximum level of filling. No emission of harmful gases during incineration. Temporary and final closure. Package 10 pcs. Capacity 0,7lt each.

 cm \varnothing 9,8 h14
G74

Suction plate for mounting G72 with a non-slip suction cup base.

cm 14x11,5

L6

Protection stand for injection needles with fixing clamp. No risk of accidental needle jabs. re-positioning of the needle into the container with one hand. The blocking mechanism means there is a safe removal of the needle from the syringe. Stainless steel, stable, approx. 220 g. Sterilizable.

 cm \varnothing 5 h3

L6



ENDODONTICS

Q1

Q1

Maxi whole plate endobox with glass cups for guttapercha.

 cm 20,5x10,5 h7



Q3

Maxi endobox composed of 5 mini boxes 72 holes.

 cm 20,5x10,5 h7

Q3



Q4

Weekly maxi endobox composed of 5 mini boxes mixed various colors.

 cm 20,5x10,5 h7



Q4

Q7

Medium endobox composed of 3 mini boxes 72 holes.

 cm 12,5x10,5 h7



Q7

Q8

Maxi round endobox.

 cm ø9,2 h7



Q8



Supplied with cover.

Q5



Q5

Mini endobox 72 holes.

 cm 10x4,2 h5

Q9

Mini endobox 48 instruments, blue colour.

 cm 10x4,2 h5



Q9

Q10

Mini endobox with small glass cups for guttapercha.

 cm 10x4,2 h5



Q10



Q15

Q15

Mini endobox mixed, red color.

 cm 10x4,2 h5



ENDODONTICS

Q78

GUTTACLEANER is an efficient organization system for gutta-percha cones and/or carriers using the embossed guide on the support. It can be used dry or in dipped in hypochlorite and can be easily positioned in the central slot of the plastic trays.

 cm 7,5x7



Q78

Q36

Round endodontic anodized aluminium holder, red color.

 cm $\varnothing 4$ h6



Q36

Q38

Q38

Round holder with glass for guttapercha, blue colour.

 cm $\varnothing 4$ h6

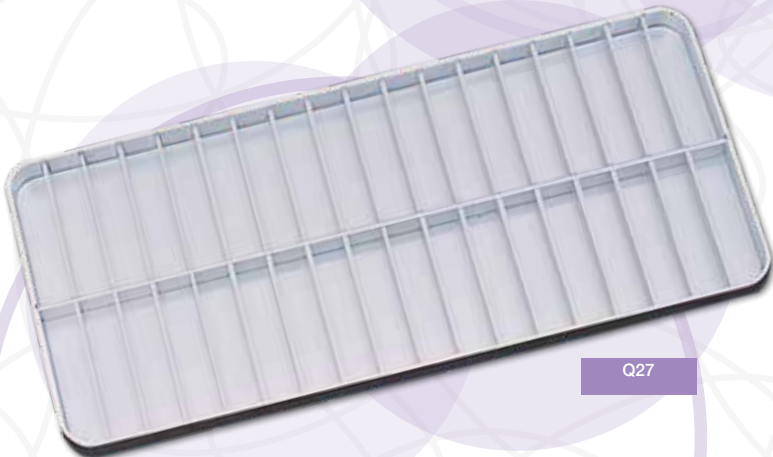

Q27

Q27

Endodontic tray, with cover.

 cm 25,5x11,5 h3



Autoclavable endoboxes with base and cover with one or more inserts.

Q40

Mini endobox 48 handpiece instruments.

 cm 12x6,8 h3,5

Q40

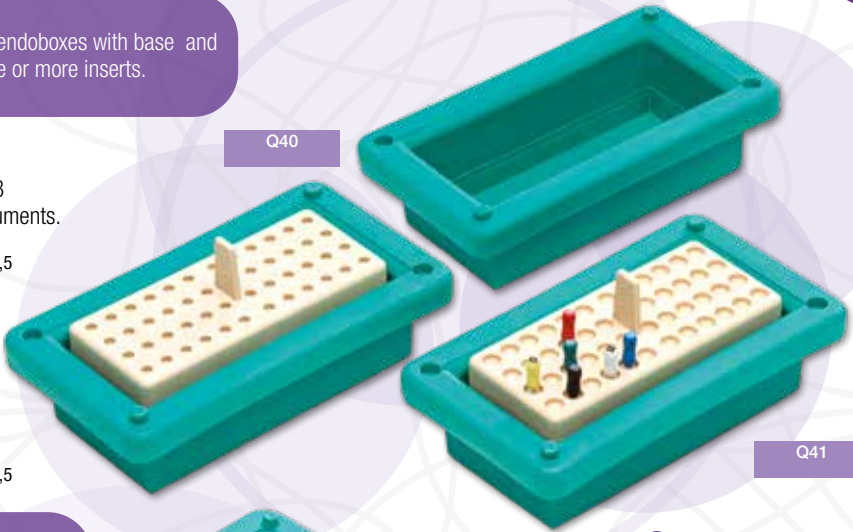

Q41

Mini endobox 48 manual instruments.

 cm 12x6,8 h3,5

Q41

Other products combination on request.

Q44

Maxi endo box mixed, 2 inserts handpiece and 2 manual instruments.

 cm 18,5x11,7 h3,5



Q44

Q50

Maxi endobox mixed, 1 insert handpiece, 1 manual, 1 FG bur, 1 RA bur.

 cm 18,5x11,7 h3,5

Q50

Q51

Round endobox for instruments and gutta cones.

 cm ø13 h3,5

Q51





ENDODONTICS

Q62

Round container with measurer for endo instruments, with sponge (model C92), blue colour. Sterilizable up to 121°.

 cm ø7,4 h6,8



Q62

C92



Endodontic sponges, 25 pcs.

 cm ø5 h1



Q65

Q65

Sterilizable holder for 16 endodontic instruments with endometer measurer and sponge for cleaning. Sterilizable up to 121°.

 cm 13,6x5 h2

Q67

Q65 holder + 25 refill sponges.

C98



Set 25 sponges for organizer Q65.

 cm 4,5x4,5

Q58

Autoclavable endo box 60 universal holes (handpieces and manual instruments). Sterilizable up to 121°.

 cm 11x5,2



Q58



Q72

Autoclavable Endo Sequencer, 8 ultrasound positions with manual indicator of the number of sterilizations performed. The support allows excellent visibility of the dental instruments and makes cleaning in the autoclave machine easier. When open, the support works as a distributor/display and measurer for files and reamers while it is useful for storing the instruments when closed.

 cm 8,3x5,4

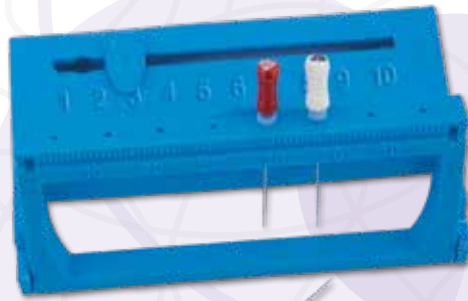

Q72



Q74

ENDOCOMFORT. A dental instrument with a unique design that allows you to check the working lengths precisely (measurement at 5/10th of a mm thanks to the special metal flap), clean the root canal instruments with the specific compressed sponge and sanitize the gutta-percha in the appropriate compartment.

 cm 19x4 h3,5

Q74-RICAMBIO

Pack of 20 replacement sponges for ENDCOMFORT Q74.

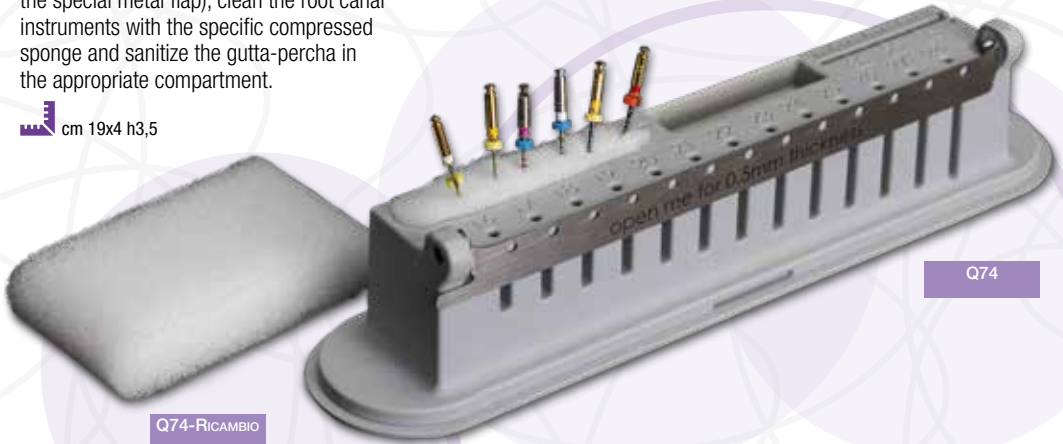

Q74

Q74-RICAMBIO

Q14

Rectangular measurer for root canal instruments, anodized alluminium.

 cm 10x4 h4



Q14



XRAY ENVELOPES AND ARCHIVES

50 super transparent hard envelopes for dental x-rays. The envelopes are printed in a writable paint.

L35

For 6 dental x-rays 3x4 cm.

 cm 14,7x10,6

L36

For 4 dental x-rays 3x4 cm.

 cm 10,2x10,6

L35

L36



L37

50 transparent envelopes for 14 dental x-rays.

 cm 38x17

L37

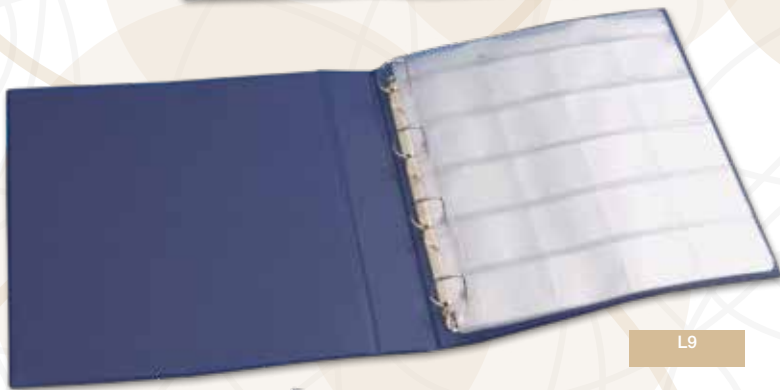

L9

L9

Envelopes for 25 x-rays, each 5x5 cm with small pockets for relative card with x-ray details. Envelopes for 25 x-rays, each 5x5 cm with small pockets for relative card with x-ray details.

 cm 21x29,7

L63

Stainless steel clip for hanging x-rays, 20 pcs.

 cm 5

L63



L10

Empty file for case L9 for 100 x-rays.

 cm 23x31

XRAY ENVELOPES AND ARCHIVES



L58

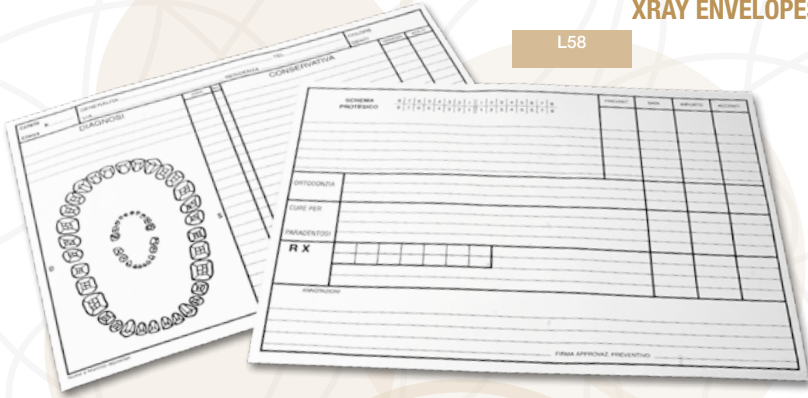

L58

Medical record for practical archiving of patient data, front and back. Packs of 100 pcs.

 cm 17x23

Transparent envelopes for cm 5x4 x-rays, 1 pen enclosed for marking envelopes.

L7

500 pcs envelopes

L8

1000 pcs envelopes

L11

500 pcs adhesive envelopes.

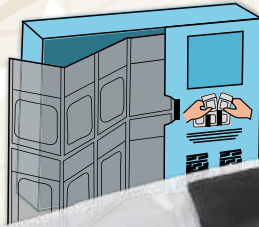

L8



L31

500 single envelopes on a reel, for 5x4 cm x-rays.



L31

50 transparent x-ray envelopes, with small pockets for x-ray card details.

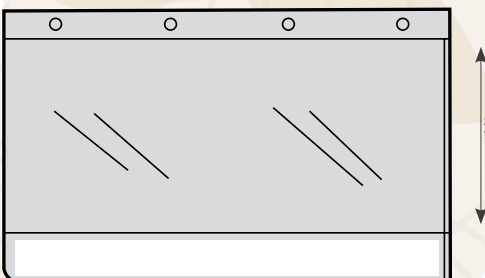

L14.2

L14.2

Useful space 30,5x16 cm

L14.3

Useful space 30,5x19 cm



CONSERVATIVE

G18

CE MD

Autoclavable plastic frame, large.

cm 12,5x10



G18

T40

CE MD

Octagonal inox handle for mouth mirrors.

cm 12,3



T40

T41

CE MD

Round handle for mouth mirrors.

cm 12,3

T41

T42

CE MD

Mouth mirrors n°4, 12 pcs.

cm Ø1,9



T42



T43

T43

CE MD

Mouth mirrors n°5, 12 pcs.

cm Ø2,3



T32

T32

Sterilizable plastic brush for dentist and laboratory.





A1 CE MD

Five plastic composite instruments, autoclavable.

 cm 15

A1



A11 CE MD

Curved amalgam gun autoclavable.

 cm 16

A12

A12 CE MD

Straight amalgam gun autoclavable.

 cm 16

A11.1 CE MD

Curved replacement tip autoclavable.

A12.1 CE MD

Straight replacement tip autoclavable.

A11



A15

White amalgam mortar, with no skid base, autoclavable.

 cm ø4 h3

A15



R55

Measuring mixing glass, autoclavable, cc 30, 100 pcs.

 cm ø4,5 h4

R55





UNIVERSAL BUR HOLDERS

L84

Bur holder for ultrasonic cleaning, 4 holes RA and 8 holes FG. Blocks open or closed, autoclavable.

AVAILABLE COLORS:



cm 7,5x3,5 h12

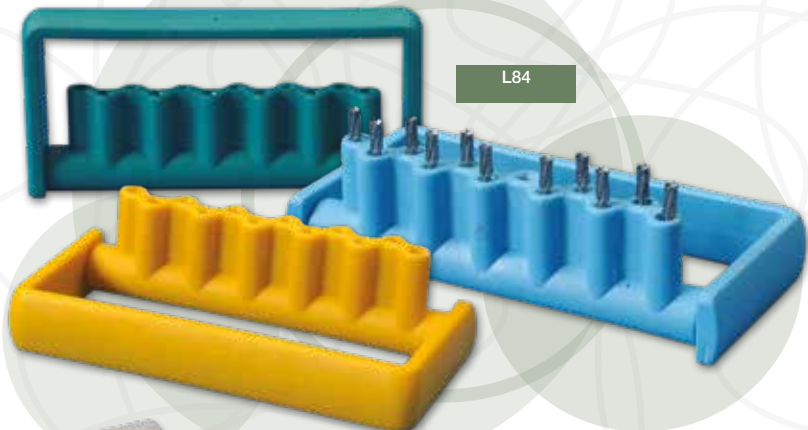

L84



Q90

Stainless steel universal holders with clip.

Q90

Universal bur holder with large diameter blue rubber pads for dental burr cutters 2,35 mm, contra-angle.

cm h4,5

Q94

Universal stand 17 holes with little blue inserts for dental burs 1,60 mm also used for turbine and micromotors.

cm 7,5x5,1 h2,9



Q94



Q96

Q96

Stainless steel bur holder with small diameter red rubber pads for dental burr cutters 1,60 mm, also used for turbines and micromotors.

cm 6x3,5 h5



L42

Bur holder with autoclavable silicone base and 35 universal holes suitable for all types of burs. Supplied with transparent plastic cover. Available in 3 colours.

AVAILABLE COLORS:



cm 5,5x4,5

L42

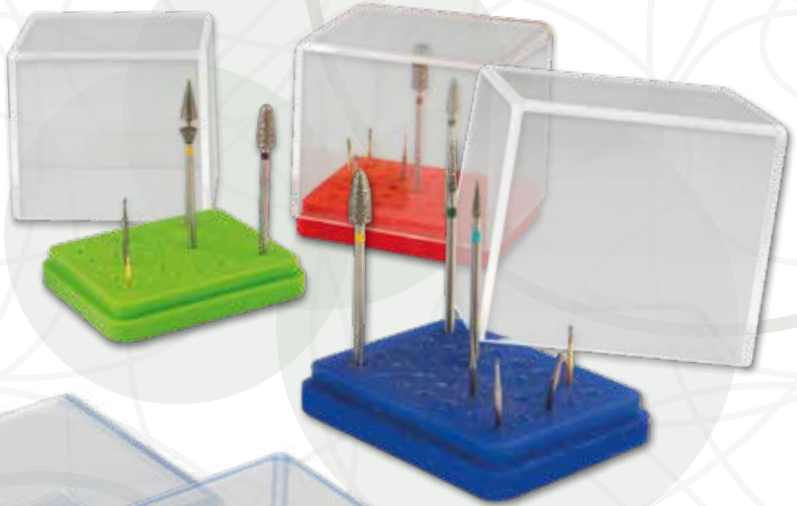

LT-1

Universal bur holder for FG and RA or implant burs. Contains 24 tips. With rubbers to block the tip. Max height bur 37 mm. Autoclavable at 121°. Transparent autoclavable lid.

AVAILABLE COLORS:



cm 6,3x4,5 h3,4
h interna da base 1,9 cm

LT-1

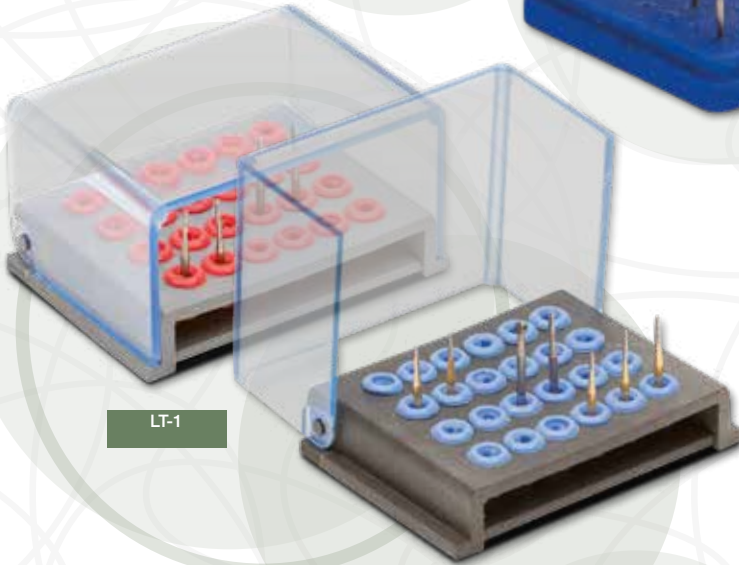

LT-2

Universal bur holder for for implantology tips and/or scalers. Contains 24 tips. With rubbers to block the tip. Max height bur 45 mm. Autoclavable at 121°. Transparent autoclavable lid.

AVAILABLE COLORS:



cm 6,3x4,5 h5
h interna da base 3,5 cm

LT-2



Bur holder fully autoclavable at 121° for implantology tips and/or scalers (high models). Rubber inserts with flaps to make them compatible with all sizes and secure the bur to stop it from coming out.



METAL BUR HOLDERS

Bur holder

sterilizable 135° in aluminium, with a lid not autoclavable, available for FG, RA, MIXED, HP.

 cm 6,6x2

LA24 24 holes

LA36 36 holes

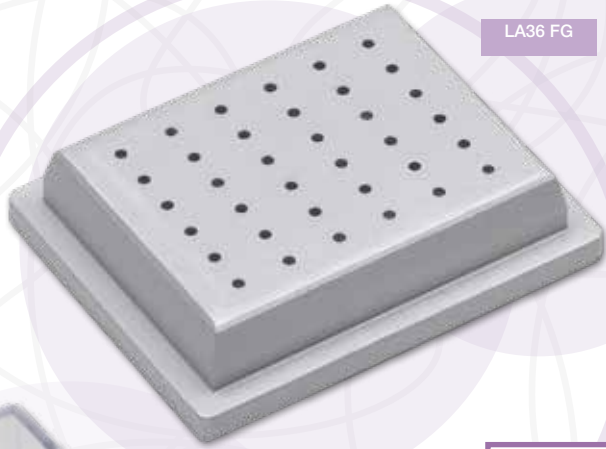

LA36 FG

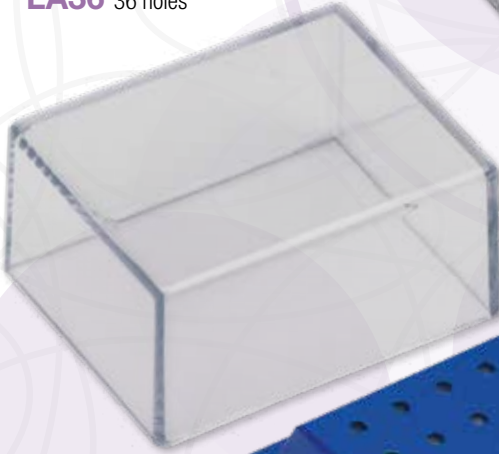

LC24

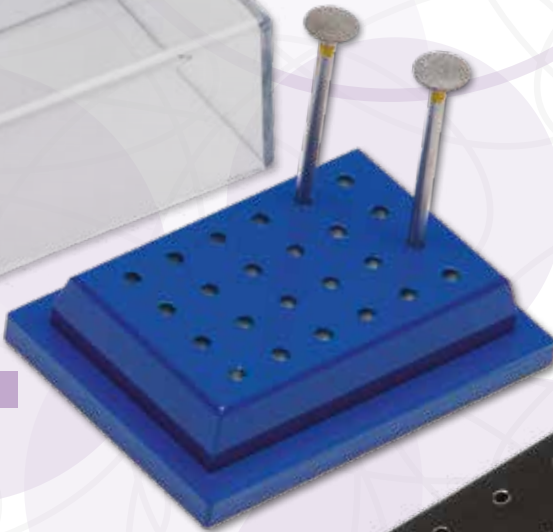

Bur holder

sterilizable 135° in varnished aluminium. 24 holes with an unsterilizable lid, available for FG, RA, MIXED, HP.

 cm 6,5x4,5

LC24 Blue

LG24 Yellow

LR24 Red

AVAILABLE COLORS:



LB24

Autoclavable 121° non-oxidizing bur holder for 24 burs, with chrome plated inserts with an unsterilizable lid. Available for FG, RA or Mixed.

 cm 8,6x6,5

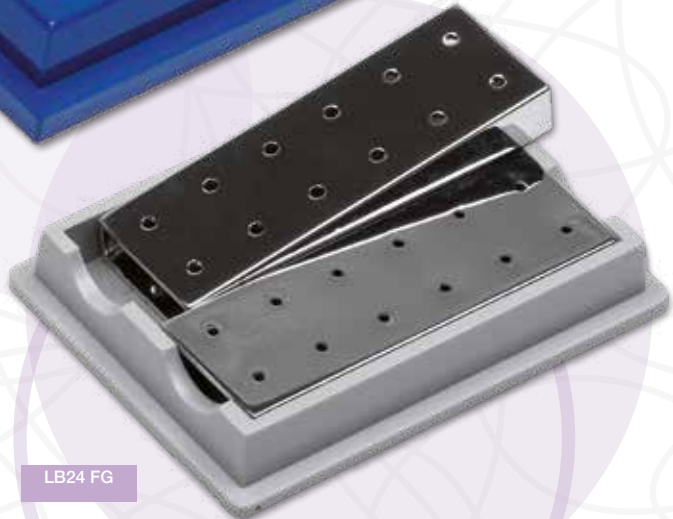

LB24 FG

STERILIZABLE BUR HOLDERS



L47-RA

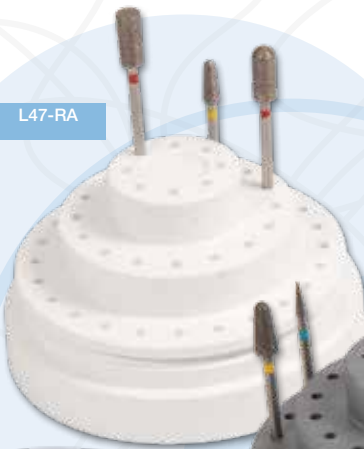

L47-MISTO



Bur holder, completely autoclavable at 121° both the base and the transparent lid, non-slip rubber base.

L47

Totally sterilizable round bur holder (base and cover).

AVAILABLE COLORS:



 cm ø8 h9,5

L47-FG

48 holes FG.

L47-RA

48 holes RA.

L47-MISTO

40 holes RA, 8 FG.

Autoclavable burs holder with base and cover with one or more inserts.

Q46 cm 18,5x11,7 h3,5
Maxi 4 inserts FG.

Q47 cm 18,5x11,7 h3,5
Maxi 4 inserts RA.

Q49 cm 18,5x11,7 h3,5
Maxi 2 x FG e 2 x RA.

Q52 cm 12x6,8 h3,5
Mini with insert FG.

Q53 cm 12x6,8 h3,5
Mini with insert RA.

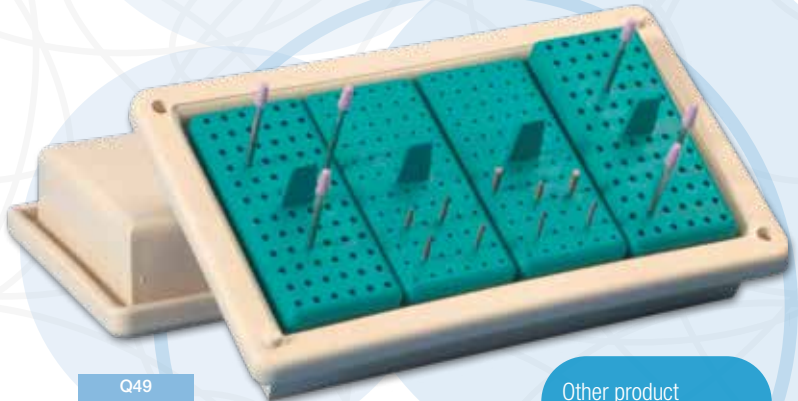

Q49

Other product combination on request.



BUR HOLDER

All models available with base for FG, RA. Mixed or high cover for HP. Bases autoclavable at up to 134°C, covers are not autoclavable.

LS12 cm 6,5x5
Holder for 12 burs.

LS18 cm 6,5x5
Holder for 18 burs.

LS24 cm 6,5x5
Holder for 24 burs.

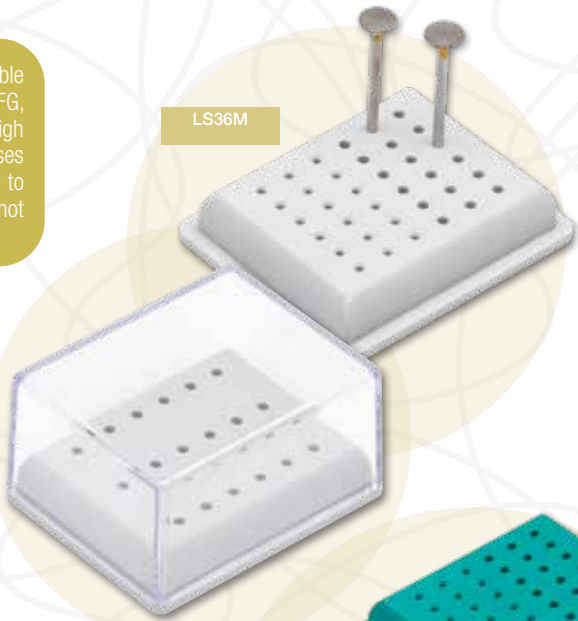

LS36M

LS36 cm 6,5x5
Holder for 36 burs.

LS48 cm 8,5x6,2
Holder for 48 burs.

LS72 cm 8,5x6,2
Holder for 72 burs.

Height of the standard lids cm 3,0. Height of the HP lids cm 5,5.

Autoclavable plastic bur holders, with transparent cover (not autoclavable), 36 holes, available with color codes for FG, RA or MIXED.
cm 6,5x5

LP36 FG
Red

LP36 RA
Blue

LP36 M
Green



LP36 M

LP36 FG

LP36 RA

Wallet for burs suitable for FG, RA and HP.



L52

L52
3 pages format 22x31 cm. Contains 5 rows for 18 burs each per page, total 270 burs.

L54

Production on request for big quantities.



L54
3 pages format 15x22 cm. Contains 4 rows for 14 burs each per page, total 168 burs.



L45

Round turnable bur stand,
4 levels, holds 120 burs
RA/HP.

AVAILABLE COLORS:  
Az Ve

 cm $\phi 5$ sup/ $\phi 12,9$ inf h7,8

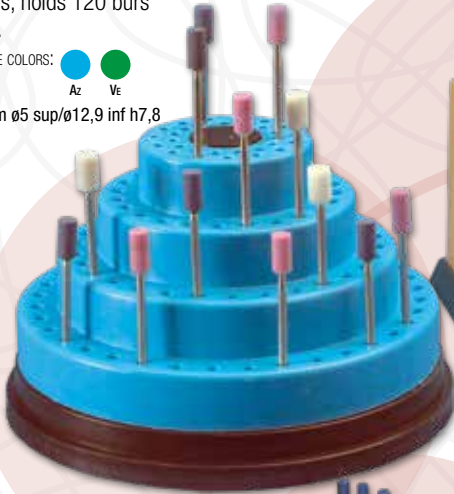

L45

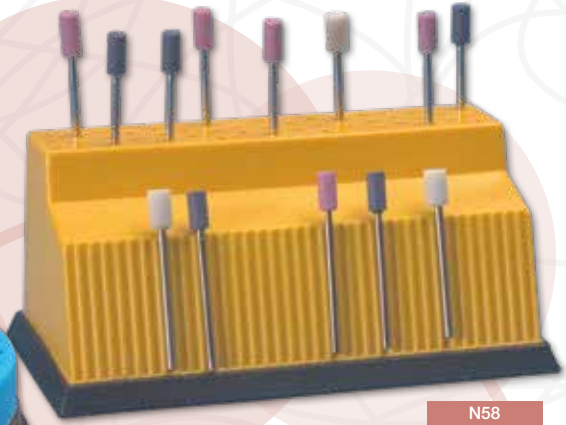

N58

N58

Magnetic plastic bur holder
and upper holes with RA/
HP for big, dental burs.

AVAILABLE COLORS:

   
Bi BL Gi Ro

 cm 14x7,6 h6,4

Plexiglass bur holder.

AVAILABLE COLORS:  
Ro/Gi

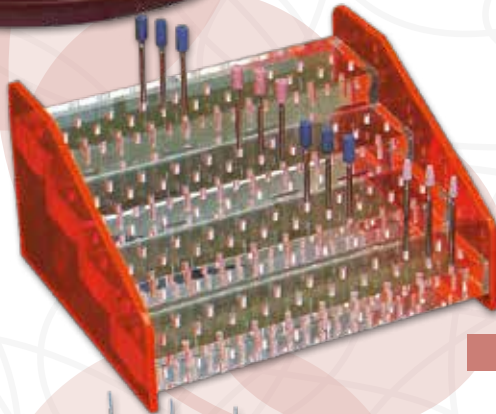

N14

N12 cm 10,5x12 h6
112 holes FG.

N14 cm 15,8x15 h8,5
116 holes for RA/HP.

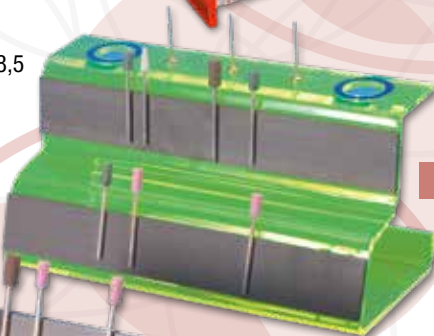

N5

N5

Plexiglass magnetic
fluorescent bur stand,
yellow.

AVAILABLE COLORS: 
Gi

 cm 20x9,4 h8

N50

Stainless steel magnetic
bur stand, blue.

AVAILABLE COLORS: 
BL

 cm 20x5,5 h6,2

N50

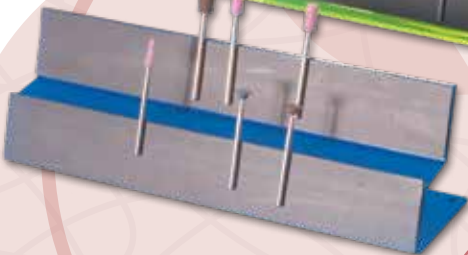



PROTECTIVE GLASSES

R58

Polycarbonate protective glasses/eyeshields with a frame that clicks into place and is autoclavable at 121°, (available in five colours). Pack includes: 1 frame + 30 adjustable protective glasses/eyeshields. Frame and shield marked L13S CER58.

Certification:
PPE CATEGORY II

AVAILABLE COLORS:



R58

R56

Polycarbonate eyeshields Thickness 0.12 mm, to be attached to a practical frame, autoclavable at 121°. The kit contains 1 frame and 30 glasses with double sided protection film.

Certification:
PPE CATEGORY I

AVAILABLE COLORS:



R56

R58-RICAMBIO

Pack includes: 12 eyeshields.

Polycarbonate visors with double protective film to guarantee absolute transparency.

R56-RICAMBIO

Pack includes: 12 eyeshields.



**OUR
CERTIFICATE**



R66

Polycarbonate protective visor, thickness mm 0.375, with a frame that clicks into place and is autoclavable at 121°. Shield with double protective film, excellent transparency, covers nose, eyes and mouth. Pack includes: 1 frame (available in blue, yellow, white, green and fuchsia) + 6 protective shields marked L13S CER66.

Certification:
PPE CATEGORY II

AVAILABLE COLORS:



THE MOST SOLD

R66



R66-RICAMBIO

Pack includes: 12 shields.

THE CHEAPEST

Polycarbonate visors with double protective film to guarantee absolute transparency.

Self-adjusting safety strap

A larger shield

R52

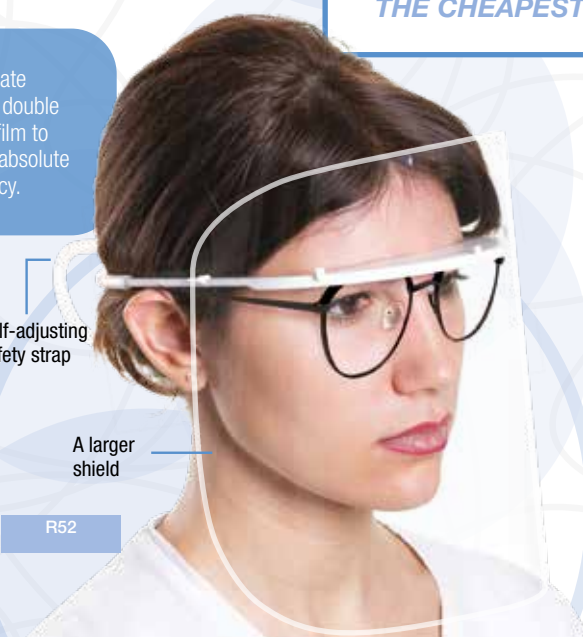

R52

Protective polycarbonate visor with interlocking frame. Thickness 0.175 mm, ultra light with high, frontal, orizontal and vertical protection, higher than the standard dimension to ensure greater coverage and rubber strap to prevent the visor from slipping. Ideal features for those who wear reading glasses (non-curved glasses arms and removable nose pad). Frame and shield marked L13S CER52.

Certification:
PPE CATEGORY II

AVAILABLE COLORS: 
Bi

R52-RICAMBIO

Pack includes: 12 shields.



PROTECTIVE VISORS

PV1

Protective visor with frame, certified according to EN166 to protect the face from splashes and small objects/splinters. Opening on the frame to allow ventilation. The loose frame means the shield can be raised above the face. Can be used with your own reading glasses underneath. Packaging: 1 frame and 2 shields.

Certification:
PPE CATEGORY II



PV1

PV1-RICAMBIO

Pack includes: 5 shields.

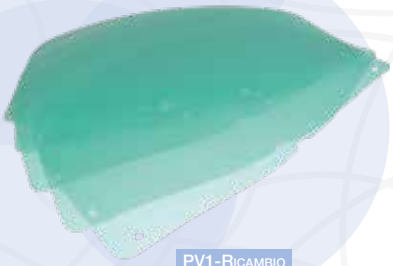

PV1-RICAMBIO



C93

C93

Stretchy rubber mask bands with slits to regulate the size and tension to the size of the user's head. Pack 5 pcs.



R5

White protective Visor with 6 shields. Thickness mm 0.375, very protective due to the bigger size. Ideal for completely covering the user's face. It has an elastic strap at the back for a better hold on the head. Frame and shield marked L13S CER5.

Certification:
PPE CATEGORY II

AVAILABLE COLORS: 
Bi

Self-adjusting safety strap

Smaller hole for better and more protection

R5

A larger shield

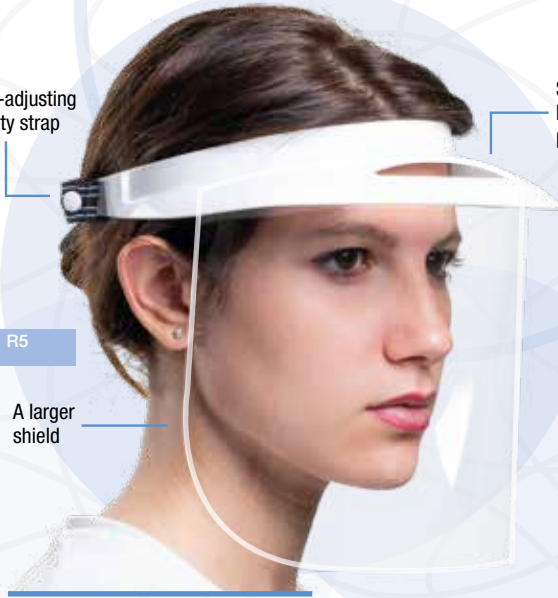

R5-RICAMBIO

Pack includes: 12 shields.

R3

Protective visor with frame, certified to protect the face from splashes and small objects/splinters. Easy visor positioning by inserting it into the slot. Opening on the frame to allow ventilation. The loose frame lets you open the shield and raise it above your face. Can be used with your own reading glasses underneath. Packaging: 1 frame and 6 shields.

Certification:
PPE CATEGORY II



R3



R3-RICAMBIO

Pack includes: 12 shields.



PROTECTIVE VISORS

R4.COLOR

Disposable protective visor with sponge and elastic, pack of 12 pcs, marked L13S CER4. Available in 4 colours.

Certification:
PPE CATEGORY II



R4

Disposable protective visor with sponge and elastic, pack of 12 pcs, marked L13S CER4.

Certification:
PPE CATEGORY II



R4.BABY

R43

Large polycarbonate visor with expanded polyethylene padding. Visor with a conformation specifically designed for use with magnifying helmets. Visor thickness 0,375. Pack includes 3 pcs.

Specific model studied specifically for who uses magnifying glasses and compatible with the most popular models (magnifying glasses Zeiss shown on the photos).



R43





PV2 CE

Enlarging optical system with magnifying glasses. Easily exchangeable types of magnifying lenses. It allows the use of your own glasses underneath. Adjustable to any face shape. Packaging contains the frame and 3 lenses (one for each 2x, 2.5x,3x).

PV3 CE

Supplied as code PV2, but with only 1 lens 2x.

PV4 CE

Supplied as code PV2, but with only 1 lens 3x.

PV5 CE

Supplied as code PV2, but with only 1 lens 2.5x.



PV3

Positive lens magnifier for precision, for hobbies and professional work. The quick exchanging of the lens and the visor offers the possibility of working with different magnifications and so the product can be used for the most disparate solutions.



Combination of magnifying lense and visor with protective shield. Protective Visor's Technical Characteristics like item code PV1.

PV3-PR CE

Supplied as code PV3 + shield.

PV4-PR CE

Supplied as code PV4 + shield.

PV5-PR CE

Supplied as code PV5 + shield.

PV3-PR



GLASS PRODUCTS

Glass mixing slab.

One side frosted glass

V41 cm 15x7 h1

Double thickness

V42 cm 15x7 h0,5

V43 cm 7x7 h0,5

V44 cm 9,5x7 h0,5

V45 cm 12,5x7 h0,5

V47 cm 10x10 h0,5

V48 cm 10x7x1,5

Transparent

V46 cm 10x10 h0,5

V45

V43

V44

Glass products cold sterilizable.

V65

Glass mortar for acrylic, plastic cover with pestle.

V26

Glass pestle.

V65

Autoclavable borosilicate **glass petri dish** (like Pyrex).

V31 cm ø6

Without compartments.

V32 cm ø8

Without compartments.

V33 cm ø10

Without compartments.

V34 cm ø10

With 2 compartments.

V35 cm ø10

With 3 compartments.

V36 cm ø10

With 4 compartments.

V33

V31

V35

V36



GLASS PRODUCTS

V1

Glass kappen with cover.

AVAILABLE COLORS:



cm ø3,2 h4,7



V1

V11

V11

Base for 5 kappen.

cm 20,7x4,7x2,2



V2

V2

Glass kappen

AVAILABLE COLORS:



cm ø2 h3



V28

V5

V28

Transparent glass super dappen.

cm ø4,5

V9



V82



V5

Transparent glass cotton wool holder.

cm ø10 h11,5

Glass products cold sterilizable.

Autoclavable borosilicate glass spirit lamp (like Pyrex).

V8

With pipe 60 gr.

V9

With pipe 100 gr.

V71



V61

V61

Frosted glass jar for disinfection.

cm sup. ø9 inf. ø7,5 h12

V81

gr 60

V82

gr 100



V7

V7

Frosted glass holder for cotton wool, with a spring.

cm sup. ø5 inf. ø6 h8

V99

Wick for glass spirit lamp, mt.

V71

Frosted glass container for waste with a stainless steel lid.

cm sup. ø5 inf. ø6 h8



MINI SANDBLASTER

Available connections to connect the micro-sandblaster to all the main turbine fittings or by using a laboratory connection going directly to the airpipe. Attachments for Borden 2 or 3 ways and for fiber optic quick couplings are NOT available.



W21

Plug for Kavo.



W21

W22

Plug for Bien Air Unifix.



W22

W23

Plug for NSK turbines.



W23

W24

Plug for Sirona.



W24

W25

Plug for Rotoquick W&H.



W25

W26

Plug for laboratory.



W26

W41

Aluminium oxide 50 micron, (fine) white color, 500 gr.



W41

W44

Aluminium oxide 95 micron, (medium) light grey color, 500 gr.



W30

W30

Autoclavable spare tip for micro sandblaster. Tip curved at 60°, internal diameter 1 mm and external 2,5 mm. To be used with specific sand between 50 and 95 microns.



W1

W1

Handy sandblaster complete with specific attachment to the turbine fitting KAVO, BIEN AIR, W&H, SIRONA, NSK or Laboratory turbine fitting (to be specified when ordering).

Extra-oral use.



The sandblaster significantly increases the adhesion of surfaces through sandblasting (for abrading the bonding surfaces of dental crowns, dental bridges and dental brackets) and it is the ideal machine for adhesion techniques. It notably reduces the risks of non-adhesion and is easy to use. The system is equipped with a special valve that allows a constant and adjustable flow of abrasive material without interruptions or pulsations. It optimizes the retention and adhesion of various dental materials such as metals, noble metals, porcelain, composite and resin. It has a standard 60° tip and is autoclavable. Dehydrated air is not necessary, even if

recommended, because humid oxide particles could join together and cause small problems. To be used at a pressure between 3 and 6 atmospheres. Available connections to connect the micro-sandblaster to all the main turbine fittings or by using a laboratory connection going directly to the airpipe. Attachments for Borden 2 or 3 ways and for fiber optic quick couplings are NOT available. The product's case contains: 1 micro sandblaster with its specific adapter, an autoclavable tip bent at 60° and 1 jar with about 30 g of 50 micron aluminum oxide.





STEAM GENERATORS

Single phase 220V/50 power (110V upon request).



VP MINI

VP MIDI

VP MAXI

VP MINI CE

Technical features: maximum absorption 1000 W, boiler capacity 2 litres, maximum pressure 3 atmospheres, weight 8 Kg, weight with package 10 Kg.

cm 16x29 h27

VP MIDI CE

Technical features: maximum absorption 1300 W, boiler capacity 3 litres, maximum pressure 3 atmospheres, weight 10 Kg, weight with package 12.5 Kg.

cm 18x35 h32

VP MAXI CE

Technical features: maximum absorption 1500 W, boiler capacity 4.9 litres. Maximum pressure 4.5 atmospheres, weight 13 Kg, weight with package 15.7 Kg.

cm 22x31 h37

CHARACTERISTICS:

- stainless steel tank
- water level control by sight
- professional jetsteam
- adjustable steam flow

VP-AUTO CE

Steam generator directly connected to the water mains. Boiler capacity 3 lt. Weight 17 kg. Pressure 4.5 atm. Stainless steel boiler thickness 4 mm. 2000 W. Electronic probe control to set the water level. Gun with switch steam and hot water from nozzle.

cm 31x26 h34,5

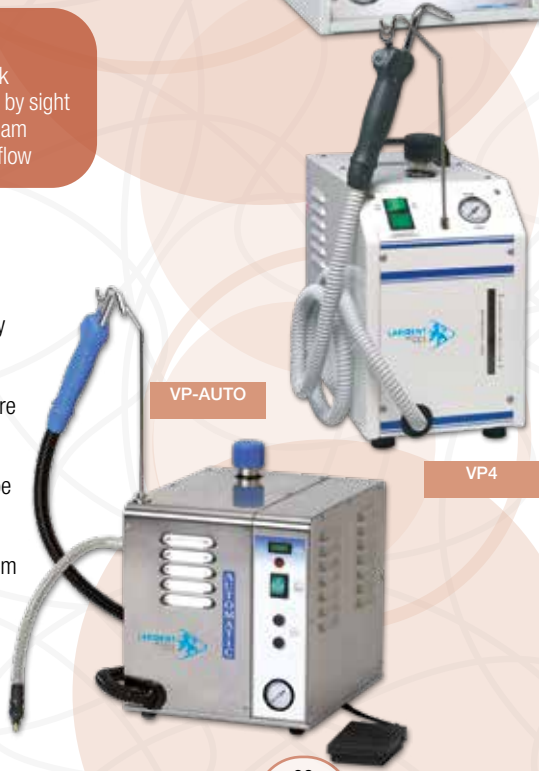

VP-AUTO

VP4

VP4 CE

Technical features: maximum absorption 1500W, boiler capacity 4 litres. Maximum pressure 4 atmospheres, weight 17 Kg, weight with package 19 Kg.

cm 21x36 h39



Larident offers a range of steam generators for use in the dental field, gold-working and art restoration industry, developed on the basis of 40 years of production experience. The products, in their various versions, are renowned for their quality, reliability and resistance.

Stainless Steel Boiler, professional insulation.

Professional steam dispenser.

Solenoid valve to adjust the quantity of steam.

One year warranty.

Visual inspection of the water level in the water tank.

Manometer to check the boiler's pressure level.





CASTING RINGS

Inox casting rings.

E30-55
mm \varnothing 30 (1x), 12 pcs

E38-55
mm \varnothing 38 1 pcs

E48-55
mm \varnothing 48 x 55 (3x), 12 pcs

E65-55
mm \varnothing 65 x 55 (6x), 6 pcs

E80-55
mm \varnothing 80 x 55 (9x), 6 pcs

Stainless steel Aisi 304
h 55 mm.

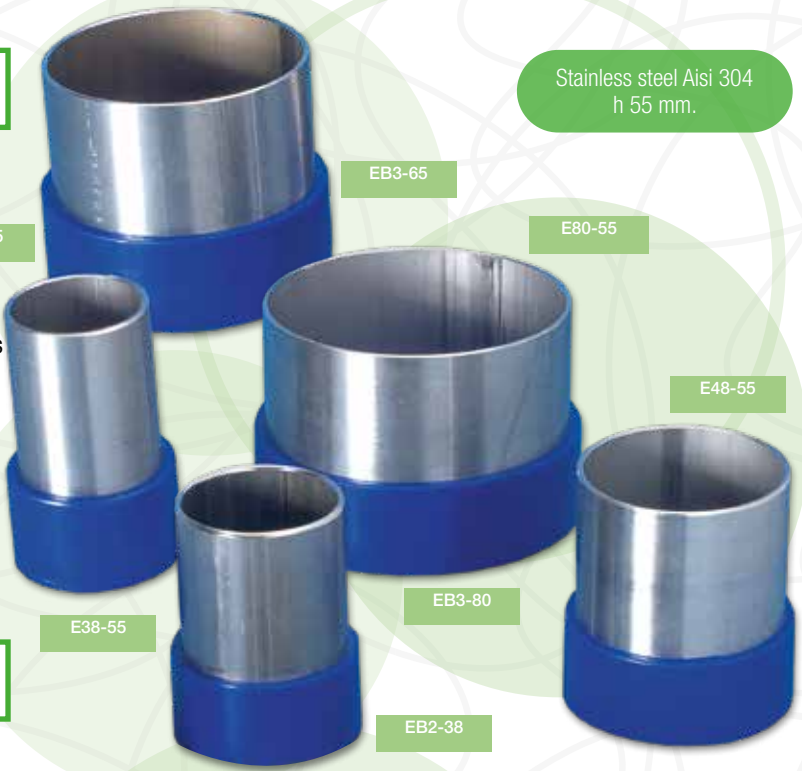

Sprue formers.

EB1
mm \varnothing 30/38/48/65/80 Base
in multiple rubber rings.

EB2
mm \varnothing 30/38/48 Base in
single rubber rings.

EB3
mm \varnothing 65/80 Base in single
rubber rings.



F22
Dental pliers for casting
rings.

cm 15



CASTING RINGS



ES6

ES9

ES1

ES3

SILICONE CONICAL CASTING RINGS

Silicone conical casting ring with plastic basestrong.

Internal sizes

ES1 1x: mm 30x55

ES3 3x: mm 48x55

ES6 6x: mm 65x55

ES9 9x: mm 80x55

PLASTIC RINGS

Plastic ring for gold ceramic with casting cone.

EP34-55 mm $\varnothing 34$ x h55

EP50-55 mm $\varnothing 50$ x h55

EP50-55

EP95-95

EP85-85

EP34-55

PLASTIC RING FOR DUPLICATION

Plastic ring for duplication investment chrome cobalt-alloy with base.

EP75-75 mm $\varnothing 75$ x h75

EP85-85 mm $\varnothing 85$ x h85

EP95-95 mm $\varnothing 95$ x h95

EP75-75

CALCINABLE

EB5

Castable, 100 pcs.



EB5



BOWLS

D1
Flexible small bowl
cm ø11 h7,5



D2

D2
Flexible middle bowl
cm ø12,5 h9

D3
Flexible large bowl
cm ø14 h11,2



D4



D14

D4
Flexible jumbo bowl
cm ø16,5 h15,4

D14
Flexible mignon bowl
cm ø8,7 h5,8

D3

D5
Semirigid bowl for plaster.
cm ø12 h9



D5



D8

D6
Rigid small bowl
cm ø10 h7

D7
Rigid middle bowl
cm ø12,5 h8,7

D8
Rigid large bowl
cm ø13,5 h11



D6

D7



Silicone bowls for resin.

D9

Small size 15 ml, 12 pcs.

 cm ø3,6 h3,3

D9-MISTO

Small size 15 ml, 12 pcs, assorted colors



D9

D11

D10

Medium size 25 ml, 6 pcs.

 cm ø5 h4,5

D11

Large size 65 ml, 3 pcs.

 cm ø6,8 h6

D12

Mini size 5 ml, 3 pcs.

 cm ø2,5 h2,8



D10

D12



D10C

Lid for medium bowls.

D10C



D11C

Lid for large bowls.



F1-BI

Soft plastic spatula for alginate, white, 6 pcs.

F2-BI

Rigid plastic spatula for alginate, white, 6 pcs.

F2-ASSORTED

Rigid plastic spatula for alginate, set 6 pcs, various colors.

F2-ASSORTED



F90

Tool that allows you to lock safely and securely any type of implant analog, without burning your fingers, during the processing phases (milling, cutting, polishing, laser welding). Ensures a natural and comfortable grip, ideal for precise and delicate operations. The tool can be used both to block analogs and as handle for manual reamers. Suitable for all analogs with a diameter from 0.5 to 6 mm.



F90



Frame the QR code to see the tutorial.



F94

F93



F89

Relining bracket made of anti-corrosive and anodized aluminum, to allow gradual cooling of the materials. Supplied with 4 self-restraining screws and extraction device. Closing knobs designed for greater precision.

F94

Bracket for large models.
 cm ø11,5 h10
Internal minimum cm 7,5

F93

Bracket for small/medium models.
 cm 11,5 h11
Internal minimum cm 7,5

F89

Flask collector with wooden handle.
 cm 13x12 h30



G65



G61

G65

Box with double foam for transporting up to 3 elements for crowns, inlays, veneers. Security lock. Pack of 100 pcs.

AVAILABLE COLORS:



cm 5,6x5 h2

G61

Box with double foam for transporting one element for crowns, inlays, veneers. Security lock. Pack of 100 pcs.

AVAILABLE COLORS:



cm 3,5x3,5 h2



G69



G69

Box with double foam for transporting circulars. Security lock. Pack of 20 pcs.

AVAILABLE COLORS:



cm 8x6,6 h4



WORK TRAYS

G36

Disposable dispatch container for 1 model with sponge. Package 10 pcs.

 cm 11,5x11,5 h4



G36

G38

Set 100 autoadhesive labels.



G32

Dispatch container for 2 models, with protective sponges. Package 10 pcs.

 cm 15x9 h7



G33

G33

Disposable dispatch container for 2 models, 10 pcs (without sponges).

 cm 15x10 h3,5



G32

G39

Dispatch container protection foams for all the boxes, 6 pcs.



G30

For 3 models.

 cm 25x15 h6

G31

G30

G31

For 1 model.

 cm 9x9 h6



G305

For models with handle.

 cm 19x13 h10

G305



Polionda non-toxic containers with lock, for orthodontic use. Made of shockproof polionda for the classification and transport of dental prosthesis and orthodontic appliances.

AVAILABLE COLORS:



G35

For all articulators, with handle.

 cm 19x19 h19

G35





WORK TRAYS

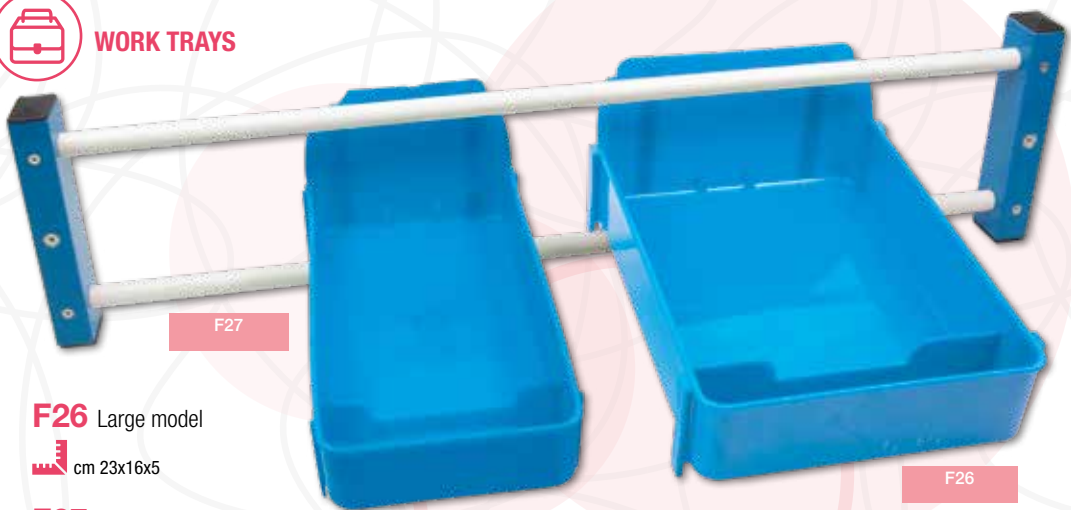

F27

F26 Large model

 cm 23x16x5

F26

F27 Small model

 cm 21,5x11x4

Metal support for F26 and F27, total length 112 cm.

F21

2 spaces of 52 cm each h14.

F23

4 spaces of 52 cm each, h34 (overlapped on two levels).

Paziente <i>Patient</i>	Paziente <i>Patient</i>
_____	_____
Data lavoro <i>Date work done</i>	Data lavoro <i>Date work done</i>
_____	_____
Note <i>Notes</i>	Note <i>Notes</i>
_____	_____
_____	_____
_____	_____

F28

Pack of 50 cardboard cards for patients' details, compatible with all work trays (G26 - G27 - F26 - F27).

 cm 16x7,5

F28

F21

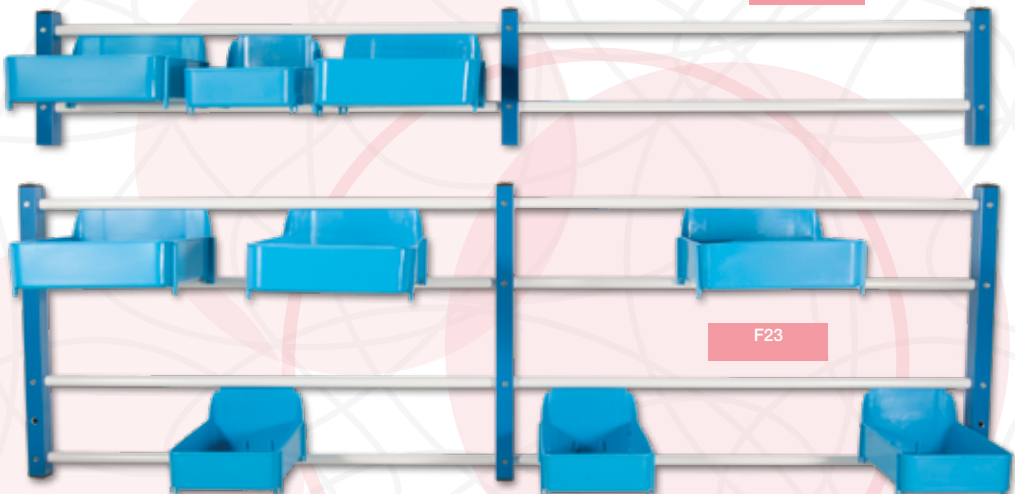

F23



G21.C

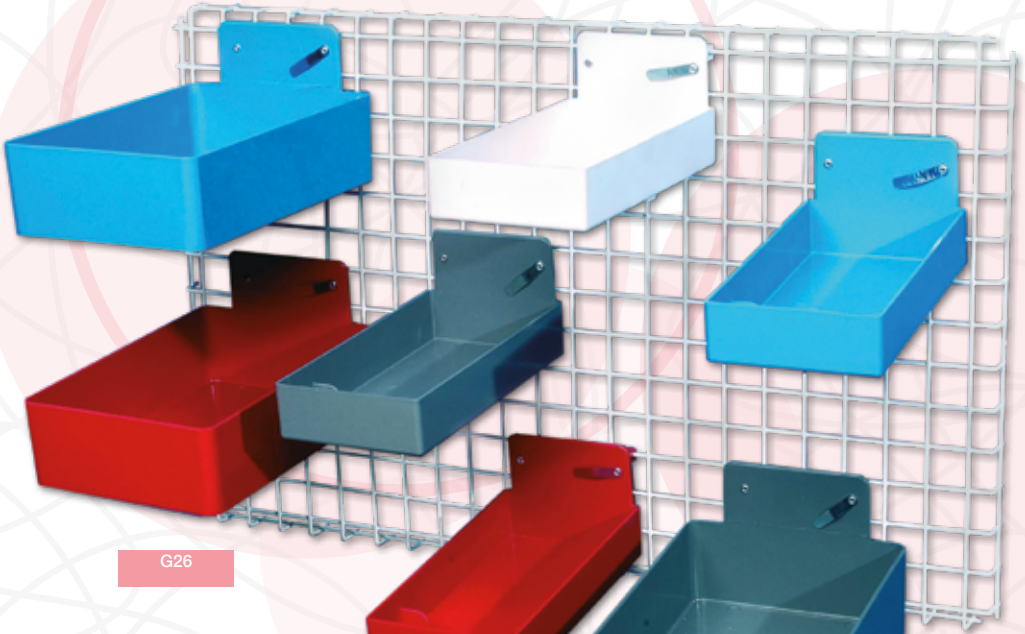

G26

Hanging work tray, large.
With clip to place notes with
working details.

AVAILABLE COLORS:



G26 Big model

 cm 23x16x11

G27 Little model

 cm 21x11x9

Metal support
for G26 and G27.

G21.C cm 71x42

G21.D cm 52x31



G27



CERAMIC BRUSHES

NATURAL BRUSHES

Ceramic brush with real marten or natural bristles.

PN00 Marten N°00

PN2 Marten N°02

PN3/P Extra flat brush N°3

PN4 Marten N°04

PN5 Marten N°05

PN7 Marten N°07

PN8 Marten N°08

PN10 Marten N°10

PN12 Marten N°12



PURA MARTORA KOLINSKY

SYNTHETIC BRUSH
Synthetic brush, really strong, black handle.

PS00
Synthetic N°00

PS2
Synthetic N°02

PS3/P
Synthetic N°03

PS4
Synthetic N°04

PS7
Synthetic N°07

PS8
Synthetic N°08

PS10
Synthetic N°10

PS12
Synthetic N°12



CERAMIC BRUSHES
Ceramic brushes, pure Kolinsky bristles, synthetic. Toray bristles in the internal part for more umidity.

PM8 Mixed N°8

PM10 Mixed N°10

PM12 Mixed N°12

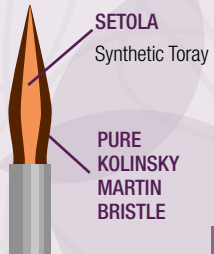

PB1
Real marten Kolinsky



SUPER BRUSH
Best quality real marten Kolinsky super brush (point size 6x21 mm). Its sharp point guarantees perfect ceramic distribution in both small and big quantities. The really thin end gives the point a long life. Metallic balls inside the ring.



NANOSINT BRUSHES

Specially made for the new techniques of micro layering and colouring on zirconium teeth to be finished. Made in Italy with new generation very thin synthetic bristles, which make them very similar to the kolinsky marten. Great resistance of the tip, which does not curl due

to wear and tear and keeps its quality for a long time. Models, PL-4 PL-9 PL-12, have the reversible aluminum handle lets the soaked tip be put inside in order to maintain the correct humidity and be used as a cover

PL-00

Ultra thin for interdental and proximal nano staining and the handle in red wood.



mm 6 bristles length
mm 0,3 base thickness

PL-0

Extra thin for micro colouring with a red wooden handle.



mm 8 bristles length
mm 0,6 base thickness

PL-1

Thin to colour with a red wooden handle.



mm 10 bristles length
mm 1 base thickness

PL-KIT

KIT of 6 Nano sint Microlayer brushes.

PL-4

Medium for micro layering and colouring, reversible aluminum handle.



mm 12 bristles length
mm 2,5 base thickness

PL-9

Medium-large compact form for dense masses or traditional ceramic with reversible aluminum handle.



mm 13 bristles length
mm 4 base thickness

PL-12

Big compact form for dense masses and traditional ceramic with a reversible aluminum handle.



mm 16 bristles length
mm 5 base thickness



PL-00



PL-0

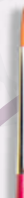

PL-1



PL-4



PL-9



PL-12



ARTICULATORS

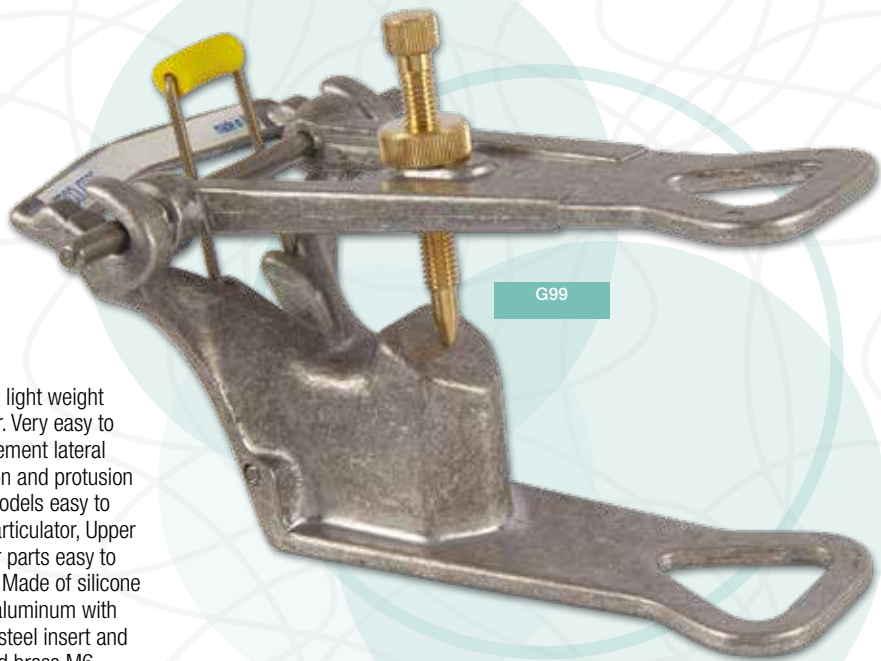

G99

G99

Extremely light weight articulator. Very easy to use. Movement lateral articulation and protrusion values. Models easy to insert in articulator, Upper and lower parts easy to separate. Made of silicone die-cast aluminum with stainless steel insert and spring and brass M6 occlusion adjusting screw.

 cm 14x10 h8 (vite registro esclusa)
misura interna cm 5,5

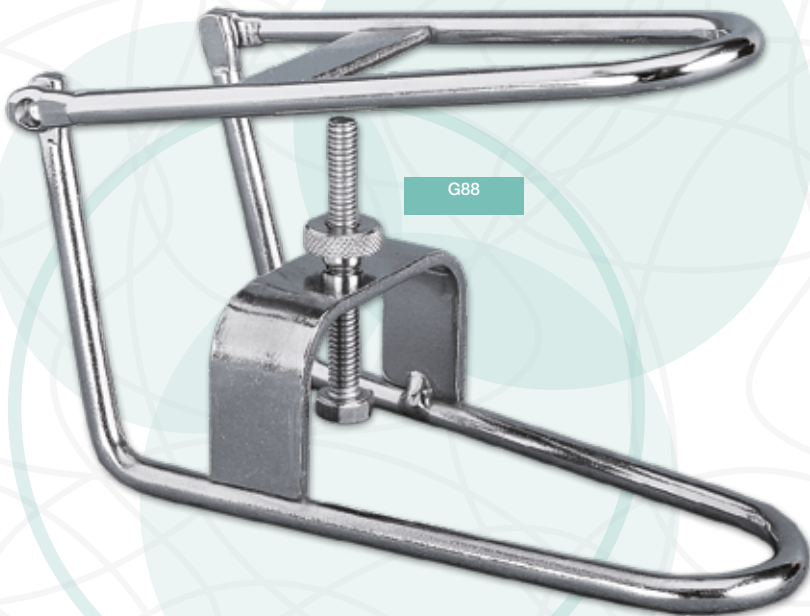

G88

G88

Chrome plated occludator articulator.

 cm 14x6,8 h7,5



G23

G23

Disposable occluder for filing, package 25 pcs.

 cm 6,5x5,2 h5,8

Plastic model trimmers, available in 2 different heights 200 pcs (100+100).

G24 cm 6x8 h6
For orthodontics.

G42 cm 7x9 h7
For false teeth.

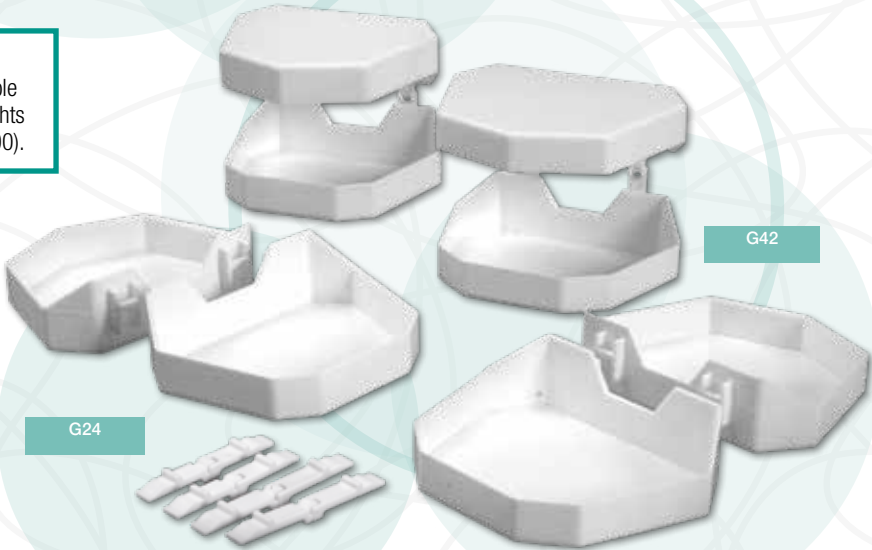

G24

G42

Plastic model trimmers, 200 pcs (100+100).

G28

Plastic Model Trimmers pcs 200 (100 + 100). Anatomically shaped edges. Cheap.

 cm 6x8,2 h6



G28



COLD-CURING RESIN

F78

Universal system for total or partial prosthesis, easy to use. Anodized aluminium base and cover in shock resistant AS. Packaging contains 2 duplicating rings: 6,5 cm and 8 cm high, 1 bowl type D2, 1 spatula type F1, 3 filling cones.

White model cm 11,5x12 h8
Green model cm 11,5x12 h6,5

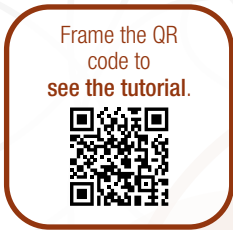

F78

Plastic transparent duplication rings for silicone

F70

Kit with three different full pieces. cm ø10,4. (1xF71, F72, F73).

Single plastic transparent duplication ring cm ø10,4.

F71 cm h5,5

F72 cm h4,5

F73 cm h3,5

Single plastic transparent partial duplication ring cm ø10,4.

F74 cm h5,5



F71

F74

F73

F72



F88

Universal flask for injection moulding of thermoplastic materials (nylon, acetal resins, etc.). Supplied with 4 self-restraining screws and model extraction device. Made of anti-corrodal and anodized aluminum, to allow gradual cooling of the material.

Injection canal height 4 cm.

 cm 11x12 h7



F88

Frame the QR code to see the tutorial.



Transparent flasks for composites

made in PMMA and base in anodized aluminium. For light-curing of bridges, crowns and arches.

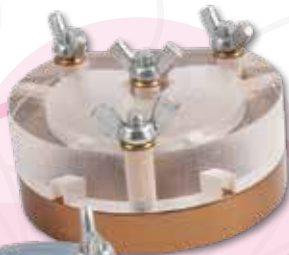

F53

F51 cm 8,5 h5

Small flask for crowns and small bridges.



F51

F53 cm 8,5 h7,5

Medium flask for frontal and partial arch dentures.



F55 cm 10,7 h8,9

Large flasks for dental arches or telescopic dentures.



F55



INSTRUMENTS

F3

Soft spatula for silicone.

 cm 13

F4

Rigid spatula for silicone.

 cm 13

F5

Stainless steel spatula for plaster.

 cm 15

F6

Plaster cutting pliers.

 cm 25

F15

Universal pliers.

 cm 15



F4

F7

F10

F11



F5

F7

Long plaster knife, with wooden handle.

 cm 17

F10

Knife for wax, with wooden handle.

 cm 17

F11

Knife for short wax, with wooden handle.

 cm 13

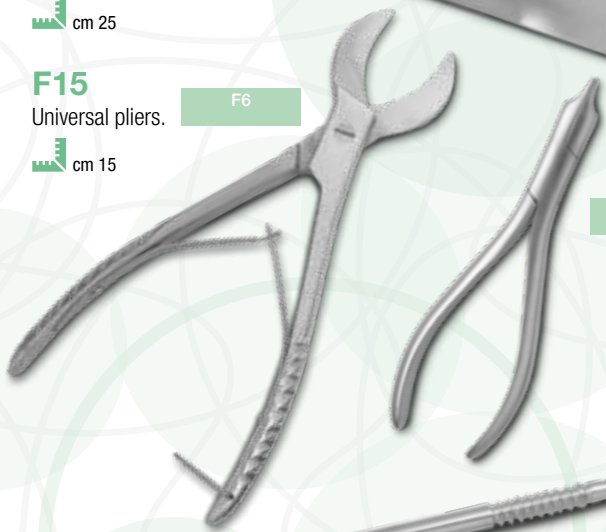

F6

F15



F13

F12

F14

F12

Spatula for modelling Hylin.

 cm 13

F13

Spatula for modelling le cron.

 cm 17

F14

Spatula for modelling zahle.

 cm 12,5



B1

Polyurethane resin for models that are harder and more precise than plaster ones. The main advantages:

- It is harder and more accurate than a class 4 plaster
- Minimum Retraction, about 0.02%
- The hardness guarantees a mechanical high quality with greater resistance on thin edges
- Ideal for casting models with thin stumps or implants
- Hardens after only ten minutes and can be used after two hours
- Resistant to a temperature of 120°
- Beige colour

The polyurethane resin model can be cleaned with steam generators and ultrasonic machines without causing dimensional changes. For impressions taken with materials based on polyether or poly-sulfide, type Impregum Premadyne Permalastic, an isolating spray must be used to coat the model. Package consists of:

- 250g of resin
- 250g of catalyst
- 750g filler
- 40 small measuring glasses
- 1 mixing cup
- 1 spatula

Frame the QR code for the instructions.



B1



B42

Pumice without quartz, extra fine, for final polishing of all acrylic materials, in packages 2,5 - 5 - 10 kg.

B42





DEVICES

F60

Hydraulic flask press for polymerizing of cold-resins. Practical and safe device operated without compressed air or electricity. Made of die-cast aluminium with double gaskets, upper and lower, to increase the pressure smoothly. Equipped with bracket and relief valve. Internal measurements cm \varnothing 10 h9.

F60.1 Dental Flask Press (without bracket)

F60.2 Bracket for Dental Flask Press

 cm 30x18,5x18

F60



G52

Plastic splash guard for cleaning machine.

 cm 28x20 h28

G52





Polycarbonate box for metallic and gold fillings, and suction hole, protective glass shield, plastic ergonomic base. Lateral holes 18x13 cm. With suction tube and no-skid adhesive supports.

G66

**G66**

Polycarbonate box for fillings.

cm 40x35 h23

G77

Box like G66, with **led light** inside and double plug.

cm 40x35 h23

G67

Replacement transparent glass for G66 and G77.

cm 25x27,5x4

G14

Transparent plexiglass box for collecting metal or plaster dusts. Lateral holes 13.5 x 9.5 cm, with anti-slide adhesive supports.

cm 31x20,5 h11/17,5



G14



BB-20

BB-20

Model of human skull that can be separated into 10 parts. Full-scale and reproduces the anatomy of a real skull.

 cm 22x11x15



Frame the QR code to download the catalog models.



BB-56

Enlarged implant made of resin material with plexiglass base, crown and screwdriver.

 cm h20

BB-56



**BB-23**

Demonstration model enlarged in scale 3:1 for the dialogue between doctor and patient with various examples of pathologies, bridges and reconstructions. Five removable elements per dental arch, transparent structure.

 cm 10x10 h5+5



BB-23

Frame the QR code to see the tutorial.



BB-14

BB-14

Model with 28 teeth for conservative and prosthetic dental practice with soft silicone gums and screwed in ivory teeth. The model has a class I normal occlusion where there are contact points. The teeth are made of "ivory".

 cm 13,5x8 h7

BB-38

Orthodontic simulator class I occlusion with crowding of the front group, composed of resin bases and special wax gums. Teeth in "ivory" material allow fixing with the normal method of use such as etchant, composites and polymerization lamp. Once the brackets are mounted, the model is immersed in a container with hot water temp. 60°C. The teeth begin to move and rotate for the normal softening of the wax until the final result is obtained. Comes with an additional wax cube. The model can be reused.

 cm 13,5x8 h7



BB-38



GADGETS

B90

B90

Textile poster showing tooth, Pop Art style.

cm 70x50



Metal key Holder.

B35

cm 6

Mirror shaped.

B36

cm 5,5

Plier shaped.

B36

B35



B98

Human skull poster (Italian language).

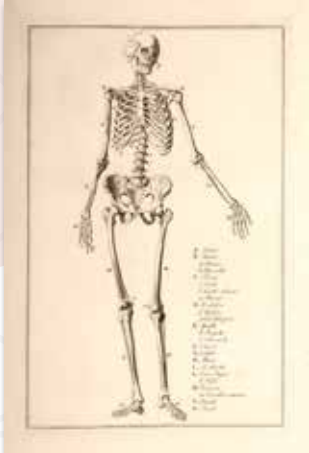

B99

Skeleton poster (Italian language).

Size cm. 50x70, without frame.

**B10**

Child's play seat. Tooth shaped reception room seat for children designed by a pedodontist. This sturdy seat, made of long-lasting plastic is suitable for any person up to 100 kg. Can be opened and so is perfect for toy storage.

AVAILABLE COLORS: 

B1

 cm ø40 h40



B10

B6

**B6**

Courage certificate for young patients, other languages available on request.

 cm 21x29,7



Larident Srl

Via Lamaneigra 12R (Ponte Rimassa) - 16030 Tribogna (Genova)
Tel. 0185 938068 - 0185 938595
www.larident.it

FOLLOW US



Printed
January 2025